

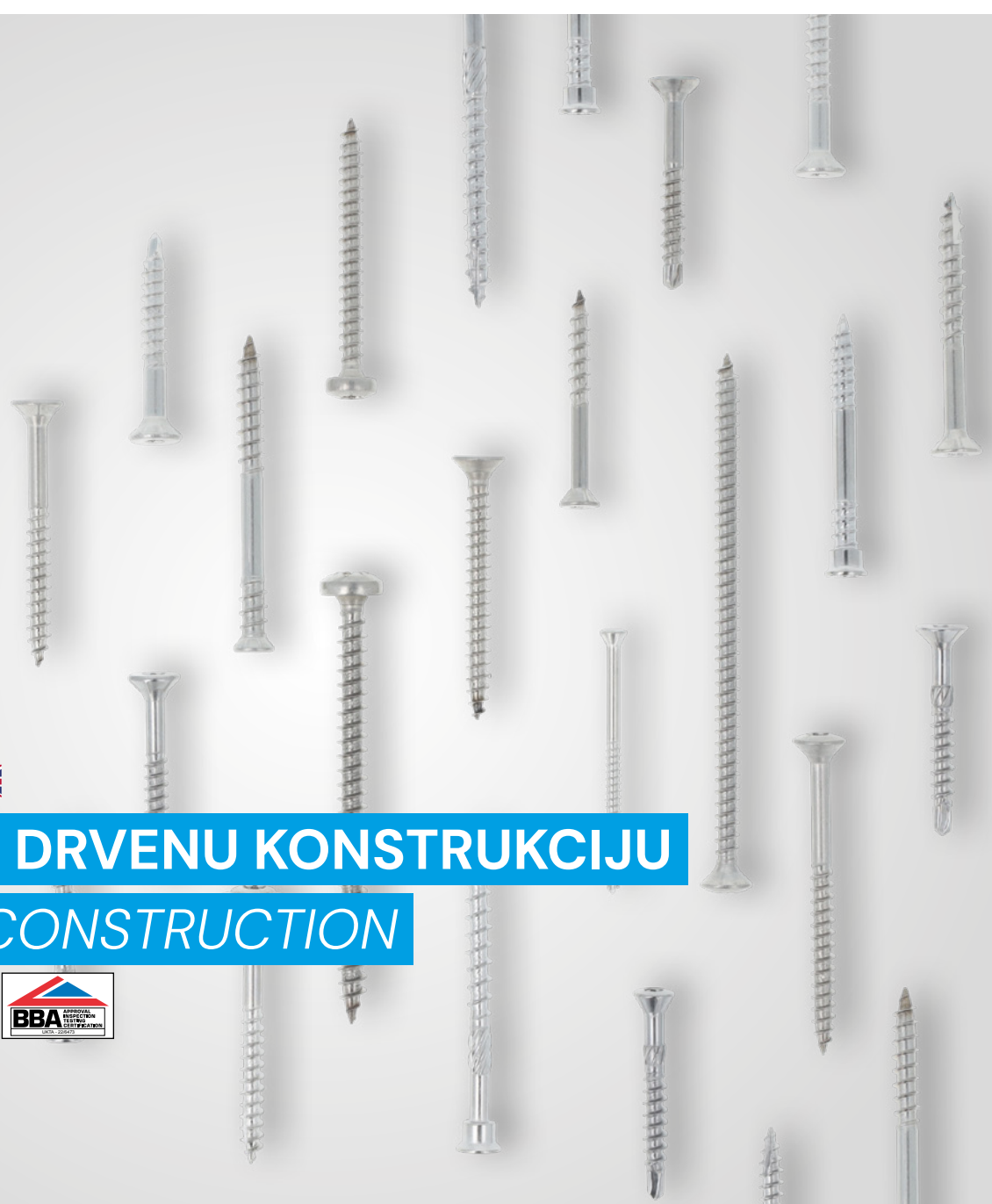

**Schäfer + Peters GmbH**  
Competence in Stainless Steel



2025  

**VIJCI ZA DRVENU KONSTRUKCIJU**

*TIMBER CONSTRUCTION*

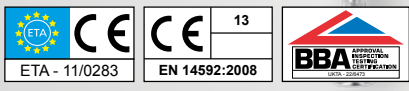



**Schäfer + Peters GmbH**  
Zeilbaumweg 32  
DE-74613 Öhringen

Tel. +49 (0) 7941 6094-0  
Fax +49 (0) 7941 6094-700

[info@schaefer-peters.com](mailto:info@schaefer-peters.com)  
[www.schaefer-peters.com](http://www.schaefer-peters.com)

**Legenda / legend**

DIN članak 

ART članak 

ISO članak 



## Dobrodošli u Schäfer + Peters

Tvrtka Schäfer + Peters vaš je partner za hrđu i spojni elementi otporni na kiseline, DIN i standardni dijelovi kao npr B. vijci za drvo, metrički vijci, vijci za lim, podloške, matice ili proizvodi kao što su pričvršćivači za teške uvjete rada, sigurnosni vijci i solar- ni pričvršćivači kao i posebni dijelovi i dijelovi za crtanje – sve u različitim verzijama.

Održavamo vezu bez hrđe s našim klijentima. To osiguravamo s preko 37.000 različitih artikala na zalihama, više od 300 predanih i kvalificiranih zaposlenika i modernim upravljanjem kvalitetom.

## Welcome to Schäfer + Peters











*Schäfer + Peters is your partner for stainless steel and anti-corrosion fasteners, DIN and standard parts such as wood screws, metric screws, tapping screws, washers, nuts and also products such as heavy-duty fastenings, safety screws and solar fastenings as well as special and drawing parts. All items are available in various versions.*

*We bond well with our customers. This relationship is backed up by us holding in excess of 37 000 different items in our warehouse, employing 270 enthusiastic and qualified members of staff and deploying modern quality management.*





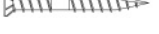







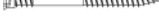

[www.schaefer-peters.com](http://www.schaefer-peters.com)









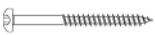

## Sadržaj Directory

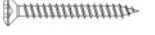
ilustracija Picture	Članak Item	Oznaka Description	Stranica Page
	Art. 9040 A2	<b>Artikl 9040 A2 TX</b> <b>Super-Drill vijci za drvo s vrhom za bušenje</b> <i>Item 9040 A2 TX</i> <i>Super-Drill CSK head timber screws with drilling point</i>	8
	Art. 9041 A2	<b>Artikl 9041 A2 TX</b> <b>Podni vijci sa šesterokrakim zvjezdastim upustom</b> <i>Item 9041 A2 TX</i> <i>Floorboard screws with six lobe drive</i>	9
	Art. 9042 A4	<b>Artikl 9042 A4 TX</b> <b>Quadra-Speed vijci s upušt glav s vrhom za rezanje</b> <i>Item 9042 A4 TX</i> <i>Quadra Speed, CSK head screws, cutting point</i>	10
	Art. 9043 C1	<b>Artikl 9043 1.4006 TX</b> <b>T-Drill vijci za mont. na terasi s vrh. za rezanje</b> <i>Item 9043 1.4006 TX</i> <i>T-Drill, RSD CSK head terrace screws, cutting point</i>	11
	Art. 9043 A2	<b>Artikl 9043 A2 TX</b> <b>T-Drill vijci za mont. na terasi s vrh. za rezanje</b> <i>Item 9043 A2 TX</i> <i>T-Drill, RSD CSK head terrace screws, cutting point</i>	12
	Art. 9043 A4	<b>Artikl 9043 A4 TX</b> <b>T-Drill vijci za mont. na terasi s vrh. za rezanje</b> <i>Item 9043 A4 TX</i> <i>T-Drill, RSD CSK head terrace screws, cutting point</i>	13
	Art. 9044 A2	<b>Artikl 9044 A2 TX</b> <b>SP-Drill vijci za stezne ploče s vrhom za rezanje</b> <i>Item 9044 A2 TX</i> <i>SP-Drill, CSK head timber screws with drilling point</i>	14
	Art. 9142 A2	<b>Artikl 9142 A2 TX</b> <b>SK-Drill vijci za terasu s upušt. glavom i urezom</b> <i>Item 9142 A2 TX</i> <i>SK-DRILL, CSK head terrace screws, cutting point</i>	15
	Art. 9142 A4	<b>Artikl 9142 A4 TX</b> <b>SK-Drill vijci za terasu s upušt. glavom i urezom</b> <i>Item 9142 A4 TX</i> <i>SK-DRILL, CSK head terrace screws, cutting point</i>	16
	Art. 9143 A2	<b>Artikl 9143 A2 TX</b> <b>TBS-Drill vijci za terasu s upušt. glavom i urezom</b> <i>Item 9143 A2 TX</i> <i>TBS-Drill CSK head terrace screws, cutting point</i>	17
	Art. 9241 C1	<b>Artikl 9241 1.4006 TX</b> <b>vijci za drvo s ukras. glavom, vrh za buš. i rebra</b> <i>Item 9241 1.4006 TX</i> <i>RSD csk head timber screws, drilling point, milling ribs</i>	18
	Art. 9242 C1	<b>Artikl 9242 1.4006 TX</b> <b>Vijci za drvo s ukras. glavom s urezom u navoju i rebrima za guljenje</b> <i>Item 9242 1.4006 TX</i> <i>RSD csk head timber screws, cutting point, milling ribs</i>	19



















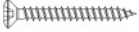



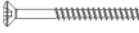



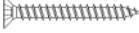







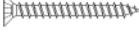





## Sadržaj Directory

ilustracija Picture	Članak Item	Oznaka Description	Stranica Page
	Art. 9242 A2	<b>Art. 9242 A2 TX</b> <b>Vijci za drvo s ukras. glavom s urezom u navoju i rebrima za guljenje</b> <i>Item 9242 A2 TX</i> <i>RSD csk head timber screws, cutting point, milling ribs</i>	20
	Art. 9242 A4	<b>Art. 9242 A4 TX</b> <b>Vijci za drvo s ukras. glavom s urezom u navoju i rebrima za guljenje</b> <i>Item 9242 A4 TX</i> <i>RSD csk head timber screws, cutting point, milling ribs</i>	21
	Art. 9242 A2	<b>Art. 9242 A2 TX smeda spaljena</b> <b>Vijci za drvo s ukras. glavom s urezom u navoju i rebrima za guljenje</b> <i>Item 9242 A2 TX burnished finish</i> <i>Timber screws RSD CSK head with cutting point and milling ribs</i>	22
	Art. 9242 A4	<b>Art. 9242 A4 TX smeda spaljena</b> <b>Vijci za drvo s ukras. glavom s urezom u navoju i rebrima za guljenje</b> <i>Item 9242 A4 TX burnished finish</i> <i>Timber screws RSD CSK head with cutting point and milling ribs</i>	23
	Art. 9243 C1	<b>9243 1.4006 TX</b> <b>TBS-Drill Vijci za terase cilindar glava</b> <i>Item 9243 1.4006 TX</i> <i>TBS-Drill, cyl. head terrace screws</i>	24
	Art. 9243 A4	<b>Artikl 9243 A4 TX</b> <b>TBS-Drill Vijci za terase cilindar glava</b> <i>Item 9243 A4 TX</i> <i>TBS-Drill, cyl. head terrace screws</i>	25
	Art. 9244 C1	<b>Artikl 9244 1.4006 TX</b> <b>Vijci s upušt. glavom za drvo, s vrhom za bušenje</b> <i>Item 9244 1.4006 TX</i> <i>CSK head timber screws with drilling point</i>	26
	Art. 9245 C1	<b>Artikl 9245 1.4006 TX</b> <b>TBS-Drill Vijci za terase, cilindar glava, usjed</b> <i>Artikel 9245 1.4006 TX</i> <i>TBS-Drill, cyl. head terrace screws, cutting point</i>	28
	Art. 9246 C1	<b>Artikl 9246 1.4006 TX</b> <b>Vijci s upušt. glavom za drvo, vrh za buš. i rebra</b> <i>Item 9246 1.4006 TX</i> <i>CSK head timber screws, drilling point, milling ribs</i>	29
	Art. 9045 A2	<b>Artikl 9045 A2 TX</b> <b>Vijci okrugle pojačane glave za ugradnju u drvo, puni navoj</b> <i>Item 9045 A2 TX</i> <i>Double pan head timber screws with fullthread</i>	31
	Art. 9045 A2	<b>Artikl 9045 A2 TX</b> <b>Vijci okrugle pojačane glave za ugradnju u drvo, djelomični navoj</b> <i>Item 9045 A2 TX</i> <i>Double pan head timber screws with partial thread</i>	32
	Art. 9045 A4	<b>Artikl 9045 A4 TX</b> <b>Vijci okrugle pojačane glave za ugradnju u drvo, puni navoj</b> <i>Item 9045 A4 TX</i> <i>Double pan head timber screws with fullthread</i>	34

## Sadržaj Directory

ilustracija Picture	Članak Item	Oznaka Description	Stranica Page
	Art. 9045 A4	<b>Artikl 9045 A4 TX</b> <b>Vijci okrugle pojačane glave za ugradnju u drvo, djelomični navoj</b> <i>Item 9045 A4 TX</i> <i>Double pan head timber screws with partial thread</i>	35
	Art. 9046 A2	<b>Artikl 9046 A2 TX</b> <b>Vijci lećaste upušć pojačane glave za stezne ploče, puni navoj</b> <i>Item 9046 A2 TX</i> <i>Double raised countersunk head timber screws with fullthread</i>	37
	Art. 9046 A2	<b>Artikl 9046 A2 TX</b> <b>Vijci lećaste upušć pojačane glave za stezne ploče, djelomični navoj</b> <i>Item 9046 A2 TX</i> <i>Double raised countersunk head timber screws with partial thread</i>	38
	Art. 9046 A4	<b>Artikl 9046 A4 TX</b> <b>Vijci lećaste upušć pojačane glave za stezne ploče, puni navoj</b> <i>Item 9046 A4 TX</i> <i>Double raised countersunk head timber screws with fullthread</i>	40
	Art. 9046 A4	<b>Artikl 9046 A4 TX</b> <b>Vijci lećaste upušć pojačane glave za stezne ploče, djelomični navoj</b> <i>Item 9046 A4 TX</i> <i>Double raised countersunk head timber screws with partial thread</i>	41
	Art. 9047 A2	<b>Artikl 9047 A2 TX</b> <b>Vijci upušćene pojačane glave za ugradnju u drvo, puni navoj</b> <i>Item 9047 A2 TX</i> <i>Double countersunk head timber screws with fullthread</i>	43
	Art. 9047 A2	<b>Artikl 9047 A2 TX</b> <b>Vijci upušćene pojačane glave za ugradnju u drvo, djelomični navoj</b> <i>Item 9047 A2 TX</i> <i>Double countersunk head timber screws with partial thread</i>	45
	Art. 9047 A4	<b>Artikl 9047 A4 TX</b> <b>Vijci upušćene pojačane glave za ugradnju u drvo, puni navoj</b> <i>Item 9047 A4 TX</i> <i>Double countersunk head timber screws with fullthread</i>	47
	Art. 9047 A4	<b>Artikl 9047 A4 TX</b> <b>Vijci upušćene pojačane glave za ugradnju u drvo, djelomični navoj</b> <i>Item 9047 A4 TX</i> <i>Double countersunk head timber screws with partial thread</i>	49
	Art. 9147 C1	<b>Art. 9147 1.4006</b> <b>Vijci s upušć. glavom za drvo s rebrima i urezom</b> <i>Item 9147 1.4006 TX</i> <i>Double CSK head timber screws with ribs, cutting point</i>	51
	Art. 9147 A2	<b>Artikl 9147 A2 TX</b> <b>Vijci s upušć. glavom za drvo s rebrima i urezom</b> <i>Item 9147 A2 TX</i> <i>Double CSK head timber screws with ribs, cutting point</i>	53
	Art. 9147 A4	<b>Artikl 9147 A4 TX</b> <b>Vijci s upušć. glavom za drvo s rebrima i urezom</b> <i>Item 9147 A4 TX</i> <i>Double CSK head timber screws with ribs, cutting point</i>	55

## Sadržaj Directory

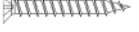
ilustracija Picture	Članak Item	Oznaka Description	Stranica Page
	 Art. 9048 A2	<b>Artikl 9048 A2 PZ</b> <b>Vijci okrugle pojačane glave za ugradnju u drvo, puni navoj</b> <i>Item 9048 A2 PZ</i> <i>Double pan head timber screws with fullthread</i>	 57 
	 Art. 9048 A2	<b>Artikl 9048 A2 PZ</b> <b>Vijci okrugle pojačane glave za ugradnju u drvo, djelomični navoj</b> <i>Item 9048 A2 PZ</i> <i>Double pan head timber screws with partial thread</i>	 59 
	 Art. 9049 A2	<b>Artikl 9049 A2 PZ</b> <b>Vijci lećaste upušć pojačane glave za stezne ploče, puni navoj</b> <i>Item 9049 A2 PZ</i> <i>Double raised countersunk head timber screws with fullthread</i>	 60 
	 Art. 9049 A2	<b>Artikl 9049 A2 PZ</b> <b>Vijci lećaste upušć pojačane glave za stezne ploče, djelomični navoj</b> <i>Item 9049 A2 PZ</i> <i>Double raised countersunk head timber screws with partial thread</i>	 61 
	 Art. 9050 A2	<b>Artikl 9050 A2 PZ</b> <b>Vijci upušćene pojačane glave za ugradnju u drvo, puni navoj</b> <i>Item 9050 A2 PZ</i> <i>Double countersunk head timber screws with fullthread</i>	 62 
	 Art. 9050 A2	<b>Artikl 9050 A2 PZ</b> <b>Vijci upušćene pojačane glave za ugradnju u drvo, djelomični navoj</b> <i>Item 9050 A2 PZ</i> <i>Double countersunk head timber screws with partial thread</i>	 63 
	 Art. 9050 A4	<b>Artikl 9050 A4 PZ</b> <b>Vijci upušćene pojačane glave za ugradnju u drvo, puni navoj</b> <i>Item 9050 A4 PZ</i> <i>Double countersunk head timber screws with fullthread</i>	 65 
	 Art. 9050 A4	<b>Artikl 9050 A4 PZ</b> <b>Vijci upušćene pojačane glave za ugradnju u drvo, djelomični navoj</b> <i>Item 9050 A4 PZ</i> <i>Double countersunk head timber screws with partial thread</i>	 66 
	 Art. 9250 A2	<b>Artikl 9250 A2 TX</b> <b>Tanjirasti vijci za ugradnju u drvo s urezom, djelomični navoj</b> <i>Item 9250 A2 TX</i> <i>Pan washer head timber screws with cutting point</i>	 68 
	 Art. 9250 A4	<b>Artikel 9250 A4 TX</b> <b>Tanjirasti vijci za ugradnju u drvo s urezom, djelomični navoj</b> <i>Item 9250 A4 TX</i> <i>Pan washer head timber screws with cutting point</i>	 70 
	 Art. 9063 A4	<b>Artikl 9063 A4</b> <b>Vijci za traku šarnira promjera glave 5 mm</b> <i>Item 9063 A4</i> <i>Hinge tape chipboardscrews with head diameter 5 mm</i>	72

## Art. 9040 A2

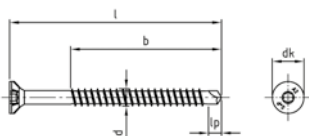

### PRIMJENE

Idealno za zavijčavanje vani, npr. za zavijčavanje oplata, ograda, šetnica, opreme za igranje, fasada i terasa. Iznimno snažni vijak kod snage za izvlačenje, kao i kod čvrstoće. Buši i tankoslojne limove od mekih materijala, npr. aluminij do debljine od 2 mm. Potrebna je minimalna dubina zavijčavanja od 4 X promjera. U idealnom slučaju trebala bi se moći ostvariti dubina zavijčavanja od 8 X promjera. U obračun se ne smije uključiti dubina veća od 12 X promjera.

### APPLICATIONS

Ideal for outdoor screw connections such as those in boarding, fences, balconies, steps, playground equipment, facades and terraces.

Can also be drilled through thin-walled soft metal sheets, e.g. aluminium up to a thickness of 2 mm.

A minimum screw-in depth of 4x the diameter must be ensured. A screw-in depth of 8x the diameter should ideally be achieved. More than 12x the diameter must not be included in calculations.

### KARAKTERISTIKE

#### SUPER-DRILL

- pojačana glava
- stabilno tijelo
- izraženi navoj
- poseban sloj za lako sklizanje
- rebra za guljenje ispod glave
- pogon s TX šesterokrakim zvjezdas-tim upustom

### FEATURES

#### SUPER-DRILL

- Reinforced head
- Stabilised shoulder
- Distinct thread
- Anti-Friction-coating
- ribs under the head
- TX drive

## Artikli 9040 A2 TX Super-Drill vijci za drvo s vrhom za bušenje

Item 9040 A2 TX

Super-Drill CSK head timber screws with drilling point

d	l	b	dk	k	lp	Veličina p Drive size	Kataloški broj Item Number	
4	25	18	8	2,5	3,5	TX20	9040240 25	200
	30	21	8	2,5	3,5	TX20	9040240 30	200
	35	26	8	2,5	3,5	TX20	9040240 35	200
	40	26	8	2,5	3,5	TX20	9040240 40	200
	45	28	8	2,5	3,5	TX20	9040240 45	200
	50	33	8	2,5	3,5	TX20	9040240 50	200
	55	36	8	2,5	3,5	TX20	9040240 55	200
	60	40	8	2,5	3,5	TX20	9040240 60	200
	65	42	8	2,5	3,5	TX20	9040240 65	200
	70	50	8	2,5	3,5	TX20	9040240 70	200
4,5	25	18	9	2,7	3,7	TX20	9040245 25	200
	30	21	9	2,7	3,7	TX20	9040245 30	200
	35	26	9	2,7	3,7	TX20	9040245 35	200
	40	26	9	2,7	3,7	TX20	9040245 40	200
	45	31	9	2,7	3,7	TX20	9040245 45	200
	50	33	9	2,7	3,7	TX20	9040245 50	200
	55	36	9	2,7	3,7	TX20	9040245 55	200
	60	40	9	2,7	3,7	TX20	9040245 60	200
	65	42	9	2,7	3,7	TX20	9040245 65	200
	70	50	9	2,7	3,7	TX20	9040245 70	200
5	80	50	9	2,7	3,7	TX20	9040245 80	200
	90	58	9	2,7	3,7	TX20	9040245 90	200
	100	58	9	2,7	3,7	TX20	9040245 100	200
	30	21	10	3	4,5	TX20	9040250 30	200
	35	26	10	3	4,5	TX20	9040250 35	200
	40	26	10	3	4,5	TX20	9040250 40	200
	45	30	10	3	4,5	TX20	9040250 45	200
	50	36	10	3	4,5	TX20	9040250 50	200
	55	36	10	3	4,5	TX20	9040250 55	200
	60	40	10	3	4,5	TX20	9040250 60	200
6	65	42	10	3	4,5	TX20	9040250 65	200
	70	50	10	3	4,5	TX20	9040250 70	200
	80	50	10	3	4,5	TX20	9040250 80	200
	90	58	10	3	4,5	TX20	9040250 90	200
	100	58	10	3	4,5	TX20	9040250 100	200
	120	66	10	3	4,5	TX20	9040250 120	200
	35	26	12	3,6	4,9	TX25	9040260 35	200
	40	26	12	3,6	4,9	TX25	9040260 40	200
	45	30	12	3,6	4,9	TX25	9040260 45	200
	50	30	12	3,6	4,9	TX25	9040260 50	200
55	36	12	3,6	4,9	TX25	9040260 55	200	
60	35	12	3,6	4,9	TX25	9040260 60	200	
65	42	12	3,6	4,9	TX25	9040260 65	200	
70	47	12	3,6	4,9	TX25	9040260 70	200	
80	57	12	3,6	4,9	TX25	9040260 80	200	
90	57	12	3,6	4,9	TX25	9040260 90	200	
100	66	12	3,6	4,9	TX25	9040260 100	100	
110	66	12	3,6	4,9	TX25	9040260 110	100	
120	66	12	3,6	4,9	TX25	9040260 120	100	
140	66	12	3,6	4,9	TX25	9040260 140	100	
150	66	12	3,6	4,9	TX25	9040260 150	100	
160	66	12	3,6	4,9	TX25	9040260 160	100	
180	66	12	3,6	4,9	TX25	9040260 180	100	
200	66	12	3,6	4,9	TX25	9040260 200	100	



## Artikl 9041 A2 TX Podni vijci sa šesterokrakim zvjezdastim upustom

Art. 9041  
A2

Item 9041 A2 TX

Floorboard screws with six lobe drive

d	l	b	dk	k	Veličina p Drive size	Kataloški broj Item Number	
3,2	25	15	5,25	3	TX10	9041232 25/15	200
	30	18	5,25	3	TX10	9041232 30/18	200
	35	24	5,25	3	TX10	9041232 35/24	200
	40	24	5,25	3	TX10	9041232 40/24	200
	50	30	5,25	3	TX10	9041232 50/30	200
	60	35	5,25	3	TX10	9041232 60/35	200

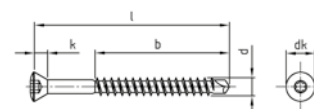

### PRIMJENE

- optimalan promjer za rubno zavijčavanje u hodnicima
- pričvršćenje oplata u podnih obloga
- zavijčavanje dekorativnih i priključnih letvica

### APPLICATIONS

- for all wood manufacturing companies (joinery, timber construction)
- everywhere you lay floorboards (in-and outside)
- optimum screw for low edge displacements

### KARAKTERISTIKE

- 60° ukrasna glava
- 6 rebra za glodanje
- vrh za bušenje

### FEATURES

- 60° Ornamental head
- 6 ribs under the head
- drilling point



## Art. 9042 A4

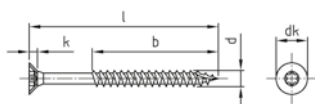

### PRIMJENE

Idealno za sve pogone koji se bave obradom drveta (stolarija, drvena gradnja, izvedba fasada) i posvuda gdje radi stručnjaci za drvenu gradnju. Kod kutnih spojeva ploča od iverice, MDF ploča i masivnog drva, za zavijčavanje s malim razmacima od ruba. Pričvršćenje okova kod izvedbe drvenih prozora, pokrovnog oblaganja te kod postavljanja drvenih elemenata na balkonu.

### APPLICATIONS

Ideal for all companies involved in wood processing (carpenters, timber construction, facade construction), in all areas in which professional woodworkers are employed.

For chipboard, MDF and solid wood corner joints, for screw connections with short edge distances.

Fastening fittings in the construction of wooden windows, cladding and balcony boards.

### KARAKTERISTIKE

- revolucionaran 4-kutni navoj
- urez u navoju
- pogon s TX šesterokrakim zvjezdastim upustom
- sigurno pričvršćenje godinama
- rebra za glodanje ispod glave

### FEATURES

- revolutionary square thread
- cutting point
- TX drive
- Secure hold for years to come
- ribs under the head



## Artikl 9042 A4 TX Quadra-Speed vijci s upušć glav s vrhom za rezanje

Item 9042 A4 TX

Quadra Speed, CSK head screws, cutting point

d	l	b	dk	k	Veličina p Drive size	Kataloški broj Item Number	
4	40	24	7,95	2,5	TX20	9042440 40/24	200
	50	30	7,95	2,5	TX20	9042440 50/30	200
	60	40	7,95	2,5	TX20	9042440 60/40	200
	70	50	7,95	2,5	TX20	9042440 70/50	200
4,5	40	24	9	2,7	TX20	9042445 40/24	200
	50	30	9	2,7	TX20	9042445 50/30	200
	60	40	9	2,7	TX20	9042445 60/40	200
5	40	24	10	3	TX25	9042450 40/24	200
	50	30	10	3	TX25	9042450 50/30	200
	60	40	10	3	TX25	9042450 60/40	200
70	50	10	3	TX25	9042450 70/50	200	
	80	60	10	3	TX25	9042450 80/60	200

## Artikl 9043 1.4006 TX T-Drill vijci za mont. na terasi s vrh. za rezanje

Art. 9043  
C1

Item 9043 1.4006 TX

T-Drill, RSD CSK head terrace screws, cutting point

d	l	b	dk	k	Veličina p Drive size	Kataloški broj Item Number	
5	40	26	7,95	3	TX25	9043400650 40	100
	50	32	7,95	3	TX25	9043400650 50	100
	60	39	7,95	3	TX25	9043400650 60	100
	70	46	7,95	3	TX25	9043400650 70	100
	80	52	7,95	3	TX25	9043400650 80	100

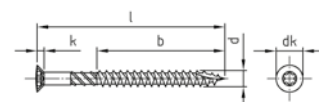

### PRIMJENE

Idealno za sve pogone koji se bave obradom drveta (stolarija, drvena gradnja) te za vrtlare i poljodjelce za primjenu pri pričvršćenju drvenog materijala za terase i kod pričvršćenja drvenih molova. Idealno rješenje čak i za tvrde vrste drva kao što su Bangkirai, Massaranduba i sl. Potrebna je minimalna dubina zavijčavanja od 4 X promjera. Ovisno o vrsti drva trebala bi se moći ostvariti dubina zavijčavanja od 8 X promjera

### APPLICATIONS

Ideal for all companies involved in wood processing (carpenters, timber construction) and all horticulturists and landscapers for fastening timbers and landing stages. Also the ideal solution for hardwoods such as Bankirai, Massaranduba, and many more.

A minimum screw-in depth of 4 x the diameter must be ensured. A screw-in depth of 8 x the diameter should be achieved depending on the wood.

### KARAKTERISTIKE

- Pojačana glava
- rebra za guljenje
- stabilno tijelo
- novi raspored bočnog navoja
- urez u navoju
- rebra za glodanje ispod glave
- pogon s TX šesterokrakim zvjezdastim upustom
- poseban sloj za lako sklizanje

### FEATURES

- Reinforced head
- milling ribs
- Stabilised shaft
- New kind of threaded flank arrangement
- cutting point
- ribs under the head
- TX drive
- Anti-Friction-coating



## Art. 9043 A2

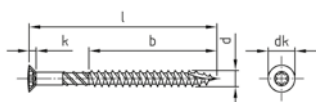

### PRIMJENE

Idealno za sve pogone koji se bave obradom drveta (stolarija, drvena gradnja) te za vrtlare i poljodjelce za primjenu pri pričvršćenju drvenog materijala za terase i kod pričvršćenja drvenih molova. Idealno rješenje čak i za tvrde vrste drva kao što su Bangkirai, Massaranduba i sl. Potrebna je minimalna dubina zavijčavanja od 4 X promjera. Ovisno o vrsti drva trebala bi se moći ostvariti dubina zavijčavanja od 8 X promjera

### APPLICATIONS

Ideal for all companies involved in wood processing (carpenters, timber construction) and all horticulturists and landscapers for fastening timbers and landing stages. Also the ideal solution for hardwoods such as Bankirai, Massaranduba, and many more.

A minimum screw-in depth of 4 x the diameter must be ensured. A screw-in depth of 8 x the diameter should be achieved depending on the wood.

### KARAKTERISTIKE

- Pojačana glava
- rebra za guljenje
- stabilno tijelo
- novi raspored bočnog navoja
- urez u navoju
- rebra za glodanje ispod glave
- pogon s TX šesterokrakim zvjezdas-tim upustom
- poseban sloj za lako sklizanje

### FEATURES

- Reinforced head
- milling ribs
- Stabilised shaft
- New kind of threaded flank arrangement
- cutting point
- ribs under the head
- TX drive
- Anti-Friction-coating



## Artikl 9043 A2 TX T-Drill vijci za mont. na terasi s vrh. za rezanje

Item 9043 A2 TX

T-Drill, RSD CSK head terrace screws, cutting point

d	l	b	dk	k	Veličina p Drive size	Kataloški broj Item Number	
5	40	26	7,95	3	TX25	9043250 40	100
	50	32	7,95	3	TX25	9043250 50	100
	60	39	7,95	3	TX25	9043250 60	100
	70	46	7,95	3	TX25	9043250 70	100
	80	52	7,95	3	TX25	9043250 80	100

## Artikl 9043 A4 TX T-Drill vijci za mont. na terasi s vrh. za rezanje

Art. 9043  
A4

Item 9043 A4 TX

T-Drill, RSD CSK head terrace screws, cutting point

d	l	b	dk	k	Veličina p Drive size	Kataloški broj Item Number	
5	40	26	7,95	3	TX25	9043450 40	100
	50	32	7,95	3	TX25	9043450 50	100
	60	39	7,95	3	TX25	9043450 60	100
	70	46	7,95	3	TX25	9043450 70	100
	80	52	7,95	3	TX25	9043450 80	100

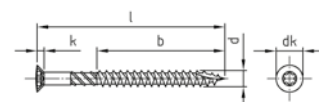

### PRIMJENE

Idealno za sve pogone koji se bave obradom drveta (stolarija, drvena gradnja) te za vrtlare i poljodjelce za primjenu pri pričvršćenju drvenog materijala za terase i kod pričvršćenja drvenih molova. Idealno rješenje čak i za tvrde vrste drva kao što su Bangkirai, Massaranduba i sl. Potrebna je minimalna dubina zavijčavanja od 4 X promjera. Ovisno o vrsti drva trebala bi se moći ostvariti dubina zavijčavanja od 8 X promjera

### APPLICATIONS

Ideal for all companies involved in wood processing (carpenters, timber construction) and all horticulturists and landscapers for fastening timbers and landing stages. Also the ideal solution for hardwoods such as Bankirai, Massaranduba, and many more.

A minimum screw-in depth of 4 x the diameter must be ensured. A screw-in depth of 8 x the diameter should be achieved depending on the wood.

### KARAKTERISTIKE

- Pojačana glava
- rebra za guljenje
- stabilno tijelo
- novi raspored bočnog navoja
- urez u navoju
- rebra za glodanje ispod glave
- pogon s TX šesterokrakim zvjezdastim upustom
- poseban sloj za lako sklizanje

### FEATURES

- Reinforced head
- milling ribs
- Stabilised shaft
- New kind of threaded flank arrangement
- cutting point
- ribs under the head
- TX drive
- Anti-Friction-coating



## Art. 9044 A2

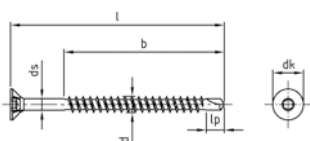

### PRIMJENE

Idealno za uobičajeno zavijčavanje vani i npr. za zavijčavanje oplata, ograda, balkona, lamela, fasada. Potrebna je minimalna dubina zavijčavanja od 4 X promjera. U idealnom slučaju trebala bi se moći ostvariti dubina zavijčavanja od 8 X promjera. U obračun se ne smije uključiti dubina veća od 12 X promjera

### APPLICATIONS

*Ideal for outdoor screw connections such as those in boarding, fences, balconies, steps, playground equipment, facades and terraces.*

*A minimum screw-in depth of 4x the diameter must be ensured. A screw-in depth of 8x the diameter should ideally be achieved. More than 12x the diameter must not be included in calculations.*

### KARAKTERISTIKE

- Nastavak za bušenje
- Rebra za glodanje ispod glave
- Pogon s TX šesterokrakim zvjezdastim upustom

### FEATURES

- drilling point
- ribs under the head
- TX drive



## Artikl 9044 A2 TX SP-Drill vijci za stezne ploče s vrhom za rezanje

Item 9044 A2 TX

SP-Drill, CSK head timber screws with drilling point

d	4	4,5	5	6
l/mm	Kat.-broj/Item no.	Kat.-broj/Item no.	Kat.-broj/Item no.	Kat.-broj/Item no.
25	9044240 25	9044245 25	9044250 25	
30	9044240 30	9044245 30	9044250 30	9044260 30
35	9044240 35	9044245 35	9044250 35	9044260 35
40	9044240 40	9044245 40	9044250 40	9044260 40
45	9044240 45	9044245 45	9044250 45	9044260 45
50	9044240 50	9044245 50	9044250 50	9044260 50
55	9044240 55	9044245 55	9044250 55	9044260 55
60	9044240 60	9044245 60	9044250 60	9044260 60
65	9044240 65	9044245 65	9044250 65	9044260 65
70	9044240 70	9044245 70	9044250 70	9044260 70
80	9044240 80	9044245 80	9044250 80	9044260 80
90		9044245 90	9044250 90	9044260 90
100		9044245 100	9044250 100	9044260 100
110				9044260 110
120			9044250 120	9044260 120
140				9044260 140
150				9044260 150
160				9044260 160
180				9044260 180
200				9044260 200

	200	200	200	200 ≥100: box = 100
dk	8	9	10	12
ds	2.84	3.11	3.54	4.25
lp	3.7	4.7	5.2	5.8
Veličina p Drive size	TX20	TX20	TX25	TX25

**Artikl 9142 A2 TX**  
**SK-Drill vijci za terasu s upušt. glavom i urezom**

**Art. 9142**  
**A2**

Item 9142 A2 TX

SK-DRILL, CSK head terrace screws, cutting point

d	l	b	dk	k	Veličina p Drive size	Kataloški broj Item Number	
4,2	28	20	7,6	3,65	TX20	9142242 28/20	250
	35	20	7,6	3,65	TX20	9142242 35/20	250
	42	22	7,6	3,65	TX20	9142242 42/22	250
4,8	56	30	7,6	3,65	TX20	9142242 56/30	250
	75	40	8,1	3,8	TX20	9142248 75/40	250
	100	60	8,1	3,8	TX20	9142248 100/60	250

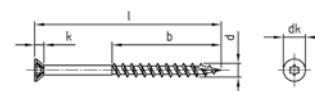

**PRIMJENE**

Idealno za zavijčavanje drvenih elemenata terase na drvene potkons-trukcije, pretežno u skandinavskom području.

**APPLICATIONS**

Ideal for bolting timbers of Terrace on wooden structures, mainly in the Scandinavian region.

**KARAKTERISTIKE**

- Upuštena glava 80°
- rebra za glodanje ispod glave
- urez u navoju
- grubi navoj
- skraćeni navoj

**FEATURES**

- 80° countersunk head
- ribs under the head
- cutting point
- coarse thread
- truncated thread



**Art. 9142  
A4**



**Artikl 9142 A4 TX  
SK-Drill vijci za terasu s upušt. glavom i urezom**

*Item 9142 A4 TX  
SK-DRILL, CSK head terrace screws, cutting point*

d	l	b	dk	k	Veličina p Drive size	Kataloški broj Item Number	
4,2	28	20	7,6	3,65	TX20	9142442 28/20	250
	35	20	7,6	3,65	TX20	9142442 35/20	250
	42	22	7,6	3,65	TX20	9142442 42/22	250
	56	30	7,6	3,65	TX20	9142442 56/30	250
4,8	75	40	8,1	3,8	TX20	9142448 75/40	250
	100	60	8,1	3,8	TX20	9142448 100/60	250

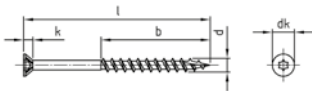

**PRIMJENE**

Idealno za zavijčavanje drvenih elemenata terase na drvene potkons-trukcije, pretežno u skandinavskom području.

**APPLICATIONS**

*Ideal for bolting timbers of Terrace on wooden structures, mainly in the Scandinavian region.*

**KARAKTERISTIKE**

- Upuštena glava 80°
- rebra za glodanje ispod glave
- urez u navoju
- grubi navoj
- skraćeni navoj

**FEATURES**

- 80° countersunk head
- ribs under the head
- cutting point
- coarse thread
- truncated thread



**Artikl 9143 A2 TX**  
**TBS-Drill vijci za terasu s upušt. glavom i urezom**

**Art. 9143**  
**A2**

Item 9143 A2 TX

TBS-Drill CSK head terrace screws, cutting point

d	l	b	dk	k	Veličina p Drive size	Kataloški broj Item Number	
5,3	40	22	7,5	3	TX20	9143253 40	100
	50	27	7,5	3	TX20	9143253 50	100
	60	27	7,5	3	TX20	9143253 60	100
	70	35	7,5	3	TX20	9143253 70	100
	80	40	7,5	3	TX20	9143253 80	100
	90	45	7,5	3	TX20	9143253 90	100
	100	50	7,5	3	TX20	9143253 100	100

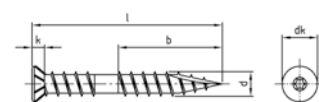

**PRIMJENE**

Idealno za sve pogone koji se bave obradom drveta (stolarija, drvena gradnja) te za vrtlare i poljodjelce za primjenu pri pričvršćenju drvenog materijala za terase i kod pričvršćenja drvenih molova. Idealno rješenje čak i za tvrde vrste drva kao što su Bangkirai, Massaranduba i sl. Potrebna je minimalna dubina zavijčavanja od 4 X promjera. Ovisno o vrsti drva trebala bi se moći ostvariti dubina zavijčavanja od 8 X promjera

**APPLICATIONS**

*Ideal for all companies involved in wood processing (carpenters, timber construction) and all horticulturists and landscapers for fastening timbers and landing stages. Also the ideal solution for hardwoods such as Bankirai, Massaranduba, and many more.*

*A minimum screw-in depth of 4 x the diameter must be ensured. A screw-in depth of 8 x the diameter should be achieved depending on the wood.*

**KARAKTERISTIKE**

- mala upuštena glava (samo 7,5 mm Ø)
- dodatni navoj donje glave
- stabilno tijelo
- vrh za rezanje
- rebra za glodanje ispod glave
- pogon s TX šesterokrakim zvjezdas-tim upustom

**FEATURES**

- Small countersunk head (diameter just 7,5 mm)
- Additional thread under the head
- Stabilised shaft
- cutting point
- ribs under the head
- TX drive



## Art. 9241 C1

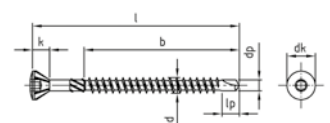
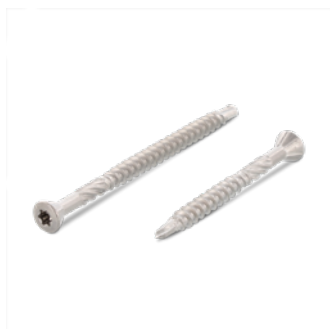

### PRIMJENE

Idealno za sve pogone koji se bave obradom drveta (stolarija, drvena gradnja) te za vrtlare i poljodjelce za primjenu pri pričvršćenju drvenog materijala za terase i kod pričvršćenja drvenih molova. Idealno rješenje čak i za tvrde vrste drva kao što su Bangkirai, Massaranduba i sl. Potrebna je minimalna dubina zavijčavanja od 4 X promjera. Ovisno o vrsti drva trebala bi se moći ostvariti dubina zavijčavanja od 8 X promjera

### APPLICATIONS

Ideal for all companies involved in wood processing (carpenters, timber construction) and all horticulturists and landscapers for fastening timbers and landing stages. Also the ideal solution for hardwoods such as Bankirai, Massaranduba, and many more.

A minimum screw-in depth of 4 x the diameter must be ensured. A screw-in depth of 8 x the diameter should be achieved depending on the wood.

### KARAKTERISTIKE

- 60° ukrasna glava
- vrh za bušenje
- rebra za guljenje
- rebra za glodanje ispod glave
- pogon s TX šesterokrakim zvjezdastim upustom
- martenzitni ojačani plemeniti čelik (1.4006)
- poseban sloj za lako sklizanje

### FEATURES

- 60° Ornamental head
- drilling point
- milling ribs
- ribs under the head
- TX drive
- Martensitic stainless steel hardened (1.4006)
- Anti-Friction-coating



## Artikl 9241 1.4006 TX vijci za drvo s ukras. glavom, vrh za buš. i rebra

Item 9241 1.4006 TX

RSD csk head timber screws, drilling point, milling ribs

d	3,2	4	4,5	5
l/mm	Kat.-broj/Item no.	Kat.-broj/Item no.	Kat.-broj/Item no.	Kat.-broj/Item no.
20	9241400632 20/14			
25	9241400632 25/17			
30	9241400632 30/18	9241400640 30/18		
35	9241400632 35/24	9241400640 35/24		
40	9241400632 40/24	9241400640 40/24	9241400645 40/24	9241400650 40/24
45		9241400640 45/30	9241400645 45/30	9241400650 45/30
50	9241400632 50/30	9241400640 50/30	9241400645 50/30	9241400650 50/30
60	9241400632 60/36	9241400640 60/36	9241400645 60/36	9241400650 60/36
70		9241400640 70/42	9241400645 70/42	9241400650 70/42
80			9241400645 80/54	9241400650 80/54
90				9241400650 90/54
100				9241400650 100/60

	500	200	200	200
dk	5	6	7	7.5
dp	2.4	2.6	3.3	3.6
k	2	2.75	3.35	3.45
lp	3.1	3.7	4.7	5.2
Veličina p Drive size	TX10	TX15	TX20	TX20

## Artikl 9242 1.4006 TX Vijci za drvo s ukras. glavom s urezom u navoju i rebrima za guljenje

Art. 9242  
C1

Item 9242 1.4006 TX

RSD csk head timber screws, cutting point, milling ribs

d	4	4,5	5
l/mm	Kat.-broj/Item no.	Kat.-broj/Item no.	Kat.-broj/Item no.
30	9242400640 30/18		
35	9242400640 35/24		
40	9242400640 40/24	9242400645 40/24	9242400650 40/24
45	9242400640 45/30	9242400645 45/30	9242400650 45/30
50	9242400640 50/30	9242400645 50/30	9242400650 50/30
60	9242400640 60/36	9242400645 60/36	9242400650 60/36
70		9242400645 70/42	9242400650 70/42
80		9242400645 80/48	9242400650 80/48
90			9242400650 90/54
100			9242400650 100/60

	200	200	200
dk	6	7	7.5
k	2.75	3.35	3.45
Veličina p Drive size	TX15	TX20	TX25

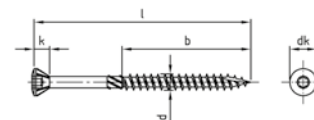

### PRIMJENE

Idealno za sve pogone koji se bave obradom drveta (stolarija, drvena gradnja) te za vrtlare i poljodjelce za primjenu pri pričvršćenju drvenog materijala za terase i kod pričvršćenja drvenih molova. Idealno rješenje čak i za tvrde vrste drva kao što su Bangkirai, Massaranduba i sl. Potrebna je minimalna dubina zavijčavanja od 4 X promjera. Ovisno o vrsti drva trebala bi se moći ostvariti dubina zavijčavanja od 8 X promjera

### APPLICATIONS

Ideal for all companies involved in wood processing (carpenters, timber construction) and all horticulturists and landscapers for fastening timbers and landing stages. Also the ideal solution for hardwoods such as Bankirai, Massaranduba, and many more.

A minimum screw-in depth of 4 x the diameter must be ensured. A screw-in depth of 8 x the diameter should be achieved depending on the wood.

### KARAKTERISTIKE

- 60° ukrasna glava
- vrh za rezanje
- rebra za guljenje
- rebra za glodanje ispod glave
- pogon s TX šesterokrakim zvjezdastim upustom
- poseban sloj za lako sklizanje

### FEATURES

- 60° Ornamental head
- cutting point
- milling ribs
- ribs under the head
- TX drive
- Anti-Friction-coating



## Art. 9242 A2

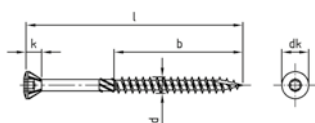

### PRIMJENE

Idealno za sve pogone koji se bave obradom drveta (stolarija, drvena gradnja) te za vrtlare i poljodjelce za primjenu pri pričvršćenju drvenog materijala za terase i kod pričvršćenja drvenih molova. Idealno rješenje čak i za tvrde vrste drva kao što su Bangkirai, Massaranduba i sl. Potrebna je minimalna dubina zavijčavanja od 4 X promjera. Ovisno o vrsti drva trebala bi se moći ostvariti dubina zavijčavanja od 8 X promjera

### APPLICATIONS

Ideal for all companies involved in wood processing (carpenters, timber construction) and all horticulturists and landscapers for fastening timbers and landing stages.

A minimum screw-in depth of 4 x the diameter must be ensured. A screw-in depth of 8 x the diameter should be achieved depending on the wood.

### KARAKTERISTIKE

- 60° ukrasna glava
- vrh za rezanje
- rebra za guljenje
- rebra za glodanje ispod glave
- pogon s TX šesterokrakim zvjezdastim upustom
- poseban sloj za lako sklizanje

### FEATURES

- 60° Ornamental head
- cutting point
- milling ribs
- ribs under the head
- TX drive
- Anti-Friction-coating



## Art. 9242 A2 TX

### Vijci za drvo s ukras. glavom s urezom u navoju i rebrima za guljenje

Item 9242 A2 TX

RSD csk head timber screws, cutting point, milling ribs

d	3,2	4	4,5	5
l/mm	Kat.-broj/Item no.	Kat.-broj/Item no.	Kat.-broj/Item no.	Kat.-broj/Item no.
25	9242232 25/17			
30	9242232 30/18	9242240 30/18		
35	9242232 35/24	9242240 35/24		
40	9242232 40/24	9242240 40/24	9242245 40/24	9242250 40/24
45		9242240 45/30	9242245 45/30	9242250 45/30
50	9242232 50/30	9242240 50/30	9242245 50/30	9242250 50/30
60	9242232 60/36	9242240 60/36	9242245 60/36	9242250 60/36
70			9242245 70/42	9242250 70/42
80			9242245 80/48	9242250 80/48
90				9242250 90/54
100				9242250 100/60

	200	200	200	200
dk	5	6	7	7,5
k	2	2,75	3,35	3,45
Veličina p Drive size	TX10	TX15	TX20	TX25

**Art. 9242 A4 TX****Vijci za drvo s ukras. glavom s urezom u navoju i rebrima za guljenje**

Item 9242 A4 TX

RSD csk head timber screws, cutting point, milling ribs

**Art. 9242****A4**

d	3,2	4	4,5	5
l/mm	Kat.-broj/Item no.	Kat.-broj/Item no.	Kat.-broj/Item no.	Kat.-broj/Item no.
25	9242432 25/17			
30	9242432 30/18	9242440 30/18		
35	9242432 35/24	9242440 35/24		
40	9242432 40/24	9242440 40/24	9242445 40/24	9242450 40/24
45		9242440 45/30	9242445 45/30	9242450 45/30
50	9242432 50/30	9242440 50/30	9242445 50/30	9242450 50/30
60	9242432 60/36	9242440 60/36	9242445 60/36	9242450 60/36
70			9242445 70/42	9242450 70/42
80			9242445 80/48	9242450 80/48
90				9242450 90/54
100				9242450 100/60

	200	200	200	200
dk	5	6	7	7.5
k	2	2.75	3.35	3.45
Veličina p Drive size	TX10	TX15	TX20	TX25

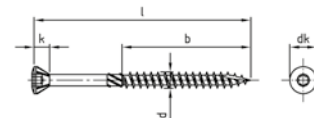
**PRIMJENE**

Idealno za sve pogone koji se bave obradom drveta (stolarija, drvena gradnja) te za vrtlare i poljodjelce za primjenu pri pričvršćenju drvenog materijala za terase i kod pričvršćenja drvenih molova. Idealno rješenje čak i za tvrde vrste drva kao što su Bangkirai, Massaranduba i sl. Potrebna je minimalna dubina zavijčavanja od 4 X promjera. Ovisno o vrsti drva trebala bi se moći ostvariti dubina zavijčavanja od 8 X promjera

**APPLICATIONS**

Ideal for all companies involved in wood processing (carpenters, timber construction) and all horticulturists and landscapers for fastening timbers and landing stages.

A minimum screw-in depth of 4 x the diameter must be ensured. A screw-in depth of 8 x the diameter should be achieved depending on the wood.

**KARAKTERISTIKE**

- 60° ukrasna glava
- vrh za rezanje
- rebra za guljenje
- rebra za glodanje ispod glave
- pogon s TX šesterokrakim zvjezdas-tim upustom
- poseban sloj za lako sklizanje

**FEATURES**

- 60° Ornamental head
- cutting point
- milling ribs
- ribs under the head
- TX drive
- Anti-Friction-coating



ETA - 11/0283



## Art. 9242 A2

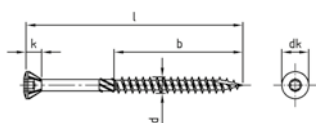

### PRIMJENE

Idealno za sve pogone koji se bave obradom drveta (stolarija, drvena gradnja) te za vrtlare i poljodjelce za primjenu pri pričvršćenju drvenog materijala za terase i kod pričvršćenja drvenih molova. Idealno rješenje čak i za tvrde vrste drva kao što su Bangkirai, Massaranduba i sl. Potrebna je minimalna dubina zavijčavanja od 4 X promjera. Ovisno o vrsti drva trebala bi se moći ostvariti dubina zavijčavanja od 8 X promjera

### APPLICATIONS

*Ideal for all companies involved in wood processing, terrace building, timber- and landing stage constructions such as carpenters, horticulturists and landscapers.*

*A minimum screw-in depth of 4 x the diameter must be ensured. A screw-in depth of 8 x the diameter should be achieved depending on the wood.*

### KARAKTERISTIKE

- 60° ukrasna glava
- vrh za rezanje
- rebra za guljenje
- rebra za glodanje ispod glave
- pogon s TX šesterokrakim zvjezdastim upustom
- poseban sloj za lako sklizanje

### FEATURES

- 60° Ornamental head
- cutting point
- milling ribs
- ribs under the head
- TX drive
- Anti-Friction-coating
- burnished finish



## Art. 9242 A2 TX smeđa spaljena Vijci za drvo s ukras. glavom s urezom u navoju i rebrima za guljenje

Item 9242 A2 TX burnished finish

Timber screws RSD CSK head with cutting point and milling ribs

d	5
l/mm	Kat.-broj/Item no.
50	9242250 50/30BRUEN
60	9242250 60/36BRUEN
70	9242250 70/42BRUEN
80	9242250 80/48BRUEN

	200
dk	7.5
k	3.45
Veličina p Drive size	TX25

## Art. 9242 A4 TX smeđa spaljena Vijci za drvo s ukras. glavom s urezom u navoju i rebrima za guljenje

Art. 9242  
A4

Item 9242 A4 TX burnished finish

Timber screws RSD CSK head with cutting point and milling ribs

d	5
l/mm	Kat.-broj/Item no.
50	9242450 50/30BRUEN
60	9242450 60/36BRUEN
70	9242450 70/42BRUEN
80	9242450 80/48BRUEN

	200
dk	7.5
k	3.45
Veličina p Drive size	TX25

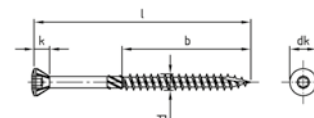

### PRIMJENE

Idealno za sve pogone koji se bave obradom drveta (stolarija, drvena gradnja) te za vrtlare i poljodjelce za primjenu pri pričvršćenju drvenog materijala za terase i kod pričvršćenja drvenih molova. Idealno rješenje čak i za tvrde vrste drva kao što su Bangkirai, Massaranduba i sl. Potrebna je minimalna dubina zavijčavanja od 4 X promjera. Ovisno o vrsti drva trebala bi se moći ostvariti dubina zavijčavanja od 8 X promjera

### APPLICATIONS

Ideal for all companies involved in wood processing, terrace building, timber- and landing stage constructions such as carpenters, horticulturists and landscapers.

A minimum screw-in depth of 4 x the diameter must be ensured. A screw-in depth of 8 x the diameter should be achieved depending on the wood.

### KARAKTERISTIKE

- 60° ukrasna glava
- vrh za rezanje
- rebra za guljenje
- rebra za glodanje ispod glave
- pogon s TX šesterokrakim zvjezdas-tim upustom
- poseban sloj za lako sklizanje

### FEATURES

- 60° Ornamental head
- cutting point
- milling ribs
- ribs under the head
- TX drive
- Anti-Friction-coating
- burnished finish



## Art. 9243 C1

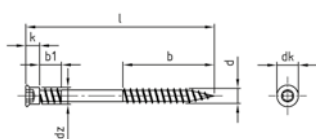

### APPLICATIONS

Ideal for all companies involved in wood processing (carpenters, timber construction) and all horticulturists and landscapers for fastening timbers and landing stages. Also the ideal solution for hardwoods such as Bankirai, Massaranduba, and many more.

A minimum screw-in depth of 4 x the diameter must be ensured. A screw-in depth of 8 x the diameter should be achieved depending on the wood.

### KARAKTERISTIKE

- Cilindarska glava
- navoj donje glave
- standardni vrh
- pogon s TX šesterokrakim zvjezdas-tim upustom
- poseban sloj za lako sklizanje

### FEATURES

- Cylinder head
- Additional thread under the head
- Standard tip
- TX drive
- Anti-Friction-coating



## 9243 1.4006 TX TBS-Drill Vijci za terase cilindar glava

Item 9243 1.4006 TX

TBS-Drill, cyl. head terrace screws

d	5,5
l/mm	Kat.-broj/Item no.
40	9243400655 40
50	9243400655 50
60	9243400655 60
70	9243400655 70
80	9243400655 80
90	9243400655 90
100	9243400655 100

	100
b1	8
dk	8
dz	6.15
k	5.1
Veličina p Drive size	TX25

## Artikl 9243 A4 TX TBS-Drill Vijci za terase cilindar glava

Item 9243 A4 TX  
TBS-Drill, cyl. head terrace screws

Art. 9243  
A4

d	5,5
l/mm	Kat.-broj/Item no.
40	9243455 40
50	9243455 50
60	9243455 60
70	9243455 70
80	9243455 80
90	9243455 90
100	9243455 100

	100
b1	8
dk	8
dz	6.15
k	5.1
Veličina p Drive size	TX25

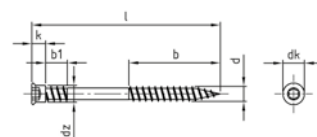

### APPLICATIONS

Ideal for all companies involved in wood processing (carpenters, timber construction) and all horticulturists and landscapers for fastening timbers and landing stages.

A minimum screw-in depth of 4 x the diameter must be ensured. A screw-in depth of 8 x the diameter should be achieved depending on the wood.

### KARAKTERISTIKE

- Cilindarska glava
- navoj donje glave
- standardni vrh
- pogon s TX šesterokrakim zvjezdas-tim upustom
- poseban sloj za lako sklizanje

### FEATURES

- Cylinder head
- Additional thread under the head
- Standard tip
- TX drive
- Anti-Friction-coating



**Art. 9244  
C1**

**Artikl 9244 1.4006 TX  
Vijci s upušt. glavom za drvo, s vrhom za bušenje**

Item 9244 1.4006 TX  
CSK head timber screws with drilling point

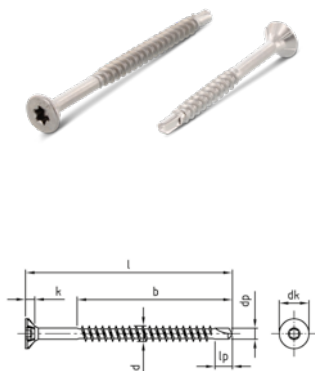

**PRIMJENE**

Idealno za sve pogone koji se bave obradom drveta (stolarija, drvena gradnja) te za vrtlare i poljodjelce za primjenu pri pričvršćenju drvenog materijala za terase i kod pričvršćenja drvenih molova. Idealno rješenje čak i za tvrde vrste drva kao što su Bangkirai, Massaranduba i sl. Potrebna je minimalna dubina zavijčavanja od 4 X promjera. Ovisno o vrsti drva trebala bi se moći ostvariti dubina zavijčavanja od 8 X promjera

**APPLICATIONS**

Ideal for all companies involved in wood processing (carpenters, timber) and all gardeners and landscapers for connection of wooden structures. Cover formwork perfectly suitable also for example in facade for wall coverings.

A minimum screw-in depth of 4 x the diameter must be ensured. A screw-in depth of 8 x the diameter should be achieved depending on the wood.

**KARAKTERISTIKE**

- Upuštena glava 90°
- vrh za bušenje
- rebra za guljenje ispod glave
- pogon s TX šesterokrakim zvjezdicastim upustom
- martenzitni ojačani plemeniti čelik (1.4006)
- poseban sloj za lako sklizanje

**FEATURES**

- countersunk 90°
- drilling point
- ribs under the head
- TX drive
- Martensitic stainless steel hardened (1.4006)
- Anti-Friction-coating



d	3,5	4	4,5	5
l/mm	Kat.-broj/Item no.	Kat.-broj/Item no.	Kat.-broj/Item no.	Kat.-broj/Item no.
20	9244400635 20/12			
25	9244400635 25/15			
30	9244400635 30/18	9244400640 30/18	9244400645 30/18	
35		9244400640 35/24	9244400645 35/24	
40		9244400640 40/24	9244400645 40/24	9244400650 40/24
45		9244400640 45/30	9244400645 45/30	9244400650 45/30
50		9244400640 50/30	9244400645 50/30	9244400650 50/30
60		9244400640 60/36	9244400645 60/36	9244400650 60/36
70		9244400640 70/42	9244400645 70/42	9244400650 70/42
80			9244400645 80/54	9244400650 80/54
90				9244400650 90/54
100				9244400650 100/60
120				
140				
160				

	500	200	200	200
dk	7	8	9	10
dp	2.8	3	3.3	3.6
k	2.1	2.5	2.7	3
lp	3.5	3.7	4.7	5.2
<b>Veličina p</b> Drive size	TX15	TX15	TX20	TX25

**Artikl 9244 1.4006 TX**  
**Vijci s upušt. glavom za drvo, s vrhom za bušenje**

**Art. 9244**  
**C1**

Item 9244 1.4006 TX

CSK head timber screws with drilling point

6

Kat.-broj/Item no.

9244400660 60/36

9244400660 80/54

9244400660 90/54

9244400660 100/60

9244400660 120/70

9244400660 140/70

9244400660 160/70

200

≥100: box=100

12

4.4

3.6

5.8

TX30

**Art. 9245  
C1**

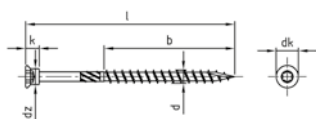

**PRIMJENE**

Idealno za sve pogone koji se bave obradom drveta (stolarija, drvena gradnja) te za vrtlare i poljodjelce za primjenu pri pričvršćenju drvenog materijala za terase i kod pričvršćenja drvenih molova. Idealno rješenje čak i za tvrde vrste drva kao što su Bangkirai, Massaranduba i sl. Potrebna je minimalna dubina zavijčavanja od 4 X promjera. Ovisno o vrsti drva trebala bi se moći ostvariti dubina zavijčavanja od 8 X promjera

**APPLICATIONS**

Ideal for all companies involved in wood processing (carpenters, timber construction) and all horticulturists and landscapers for fastening timbers and landing stages. Also the ideal solution for hardwoods such as Bankirai, Massaranduba, and many more.

A minimum screw-in depth of 4 x the diameter must be ensured. A screw-in depth of 8 x the diameter should be achieved depending on the wood.

**KARAKTERISTIKE**

- Cilindarska glava
- rebra za guljenje
- vrh za rezanje
- pogon s TX šesterokrakim zvjezastim upustom
- martenzitni ojačani plemeniti čelik (1.4006)
- poseban sloj za lako sklizanje

**FEATURES**

- Cylinder head
- milling ribs
- cutting point
- TX drive
- Martensitic stainless steel hardened (1.4006)
- Anti-Friction-coating



**Artikl 9245 1.4006 TX  
TBS-Drill Vijci za terase, cilindar glava, usjed**

Artikel 9245 1.4006 TX

TBS-Drill, cyl. head terrace screws, cutting point

d	4	4,5	5
l/mm	Kat.-broj/Item no.	Kat.-broj/Item no.	Kat.-broj/Item no.
40	9245400640 40/24		
45	9245400640 45/24	9245400645 45/24	9245400650 45/24
50	9245400640 50/30	9245400645 50/30	9245400650 50/30
60	9245400640 60/36	9245400645 60/36	9245400650 60/36
70	9245400640 70/42	9245400645 70/42	9245400650 70/42
80		9245400645 80/48	9245400650 80/48
90			9245400650 90/54
100			9245400650 100/60

	200	200	100
dk	5.7	7.05	8.75
dz	3.95	5.35	6.15
k	4.35	4.8	5.45
Veličina p Drive size	TX15	TX20	TX25

## Artikl 9246 1.4006 TX Vijci s upuš. glavom za drvo, vrh za buš. i rebra

Art. 9246  
C1

Item 9246 1.4006 TX

CSK head timber screws, drilling point, milling ribs

d	3,5	4	4,5	5
l/mm	Kat.-broj/Item no.	Kat.-broj/Item no.	Kat.-broj/Item no.	Kat.-broj/Item no.
25	9246400635 25/15			
30	9246400635 30/18	9246400640 30/18	9246400645 30/18	
35		9246400640 35/24	9246400645 35/24	
40		9246400640 40/24	9246400645 40/24	9246400650 40/24
45		9246400640 45/30	9246400645 45/30	9246400650 45/30
50		9246400640 50/30	9246400645 50/30	9246400650 50/30
60		9246400640 60/36	9246400645 60/36	9246400650 60/36
70		9246400640 70/42	9246400645 70/42	9246400650 70/42
80			9246400645 80/54	9246400650 80/54
90				9246400650 90/54
100				9246400650 100/60
120				
140				
160				

Više dimenzija na sljedećoj stranici. / Further dimensions on the next page.

	500	200	200	200
dp	2.8	3	3.3	3.6
k	2.1	2.5	2.7	3
lp	3.5	3.7	4.7	5.2
Veličina p Drive size	TX15	TX15	TX20	TX25

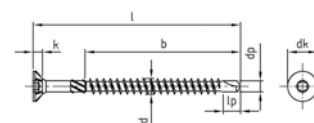

### PRIMJENE

Idealno za sve pogone koji se bave obradom drveta (stolarija, drvena gradnja) te za vrtlare i poljodjelce za primjenu pri pričvršćenju drvenog materijala za terase i kod pričvršćenja drvenih molova. Idealno rješenje čak i za tvrde vrste drva kao što su Bangkirai, Massaranduba i sl. Potrebna je minimalna dubina zavijčavanja od 4 X promjera. Ovisno o vrsti drva trebala bi se moći ostvariti dubina zavijčavanja od 8 X promjera

### APPLICATIONS

Ideal for all companies involved in wood processing (carpenters, timber construction) and all horticulturists and landscapers for fastening timbers and landing stages. Also the ideal solution for hardwoods such as Bankirai, Massaranduba, and many more.

A minimum screw-in depth of 4 x the diameter must be ensured. A screw-in depth of 8 x the diameter should be achieved depending on the wood.

### KARAKTERISTIKE

- Upuštena glava 90°
- vrh za bušenje
- rebra za guljenje ispod glave
- rebra za glodanje
- pogon s TX šesterokrakim zvjezdastim upustom
- martenzitni ojačani plemeniti čelik (1.4006)
- poseban sloj za lako sklizanje

### FEATURES

- countersunk 90°
- drilling point
- ribs under the head
- milling ribs
- TX drive
- Martensitic stainless steel hardened (1.4006)
- Anti-Friction-coating



**Art. 9246  
C1**

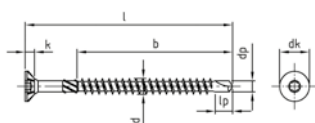

**PRIMJENE**

Idealno za sve pogone koji se bave obradom drveta (stolarija, drvena gradnja) te za vrtlare i poljodjelce za primjenu pri pričvršćenju drvenog materijala za terase i kod pričvršćenja drvenih molova. Idealno rješenje čak i za tvrde vrste drva kao što su Bangkirai, Massaranduba i sl. Potrebna je minimalna dubina zavijčavanja od 4 X promjera. Ovisno o vrsti drva trebala bi se moći ostvariti dubina zavijčavanja od 8 X promjera

**APPLICATIONS**

Ideal for all companies involved in wood processing (carpenters, timber construction) and all horticulturists and landscapers for fastening timbers and landing stages. Also the ideal solution for hardwoods such as Bankirai, Massaranduba, and many more.

A minimum screw-in depth of 4 x the diameter must be ensured. A screw-in depth of 8 x the diameter should be achieved depending on the wood.

**KARAKTERISTIKE**

- Upuštena glava 90°
- vrh za bušenje
- rebra za guljenje ispod glave
- rebra za glodanje
- pogon s TX šesterokrakim zvjezdastim upustom
- martenzitni ojačani plemeniti čelik (1.4006)
- poseban sloj za lako sklizanje

**FEATURES**

- countersunk 90°
- drilling point
- ribs under the head
- milling ribs
- TX drive
- Martensitic stainless steel hardened (1.4006)
- Anti-Friction-coating



**Artikl 9246 1.4006 TX  
Vijci s upušt. glavom za drvo, vrh za buš. i rebra**

Item 9246 1.4006 TX  
CSK head timber screws, drilling point, milling ribs

d	6
l/mm	Kat.-broj/Item no.
25	
30	
35	
40	
45	
50	
60	9246400660 60/36
70	
80	9246400660 80/54
90	9246400660 90/54
100	9246400660 100/60
120	9246400660 120/70
140	9246400660 140/70
160	9246400660 160/70

	200 ≥100: box = 100
dp	4.4
k	3.6
lp	5.8
Veličina p Drive size	TX25

## Artikl 9045 A2 TX Vijci okrugle pojačane glave za ugradnju u drvo, puni navoj

Art. 9045  
A2

Item 9045 A2 TX

Double pan head timber screws with fullthread

d	3	3,5	4	4,5	5	6
l/mm	Kat.-broj/Item no.	Kat.-broj/Item no.	Kat.-broj/Item no.	Kat.-broj/Item no.	Kat.-broj/Item no.	Kat.-broj/Item no.
10	9045230 10	9045235 10	9045240 10			
12	9045230 12	9045235 12	9045240 12	9045245 12		
16	9045230 16	9045235 16	9045240 16	9045245 16	9045250 16	
20	9045230 20	9045235 20	9045240 20	9045245 20	9045250 20	9045260 20
25	9045230 25	9045235 25	9045240 25	9045245 25	9045250 25	9045260 25
30	9045230 30	9045235 30	9045240 30	9045245 30	9045250 30	9045260 30
35	9045230 35	9045235 35	9045240 35	9045245 35	9045250 35	9045260 35
40	9045230 40	9045235 40	9045240 40	9045245 40	9045250 40	9045260 40
45		9045235 45	9045240 45	9045245 45	9045250 45	9045260 45
50		9045235 50	9045240 50	9045245 50	9045250 50	9045260 50
55			9045240 55	9045245 55	9045250 55	9045260 55
60			9045240 60	9045245 60	9045250 60	9045260 60
65			9045240 65	9045245 65	9045250 65	9045260 65
70			9045240 70	9045245 70	9045250 70	9045260 70
80				9045245 80	9045250 80	9045260 80
90					9045250 90	9045260 90
100					9045250 100	9045260 100
110						9045260 110

	500	500	500 ≥40: box = 200	500 ≥40: box = 200	500 ≥40: box = 200 ≥60: box = 100	100
dk	6	7	8	9	10	12
k	2.5	2.6	3	3.1	3.7	4.7
Veličina p Drive size	TX10	TX10	TX20	TX20	TX25	TX25

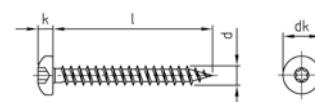

### PRIMJENE

Idealno za zavijčavanje u drvu. Optimalna geometrija navoja osigurava najbolju čvrstoću u različitim drvenim materijalima. TX prihvata omogućava optimalan prijenos snage.

### APPLICATIONS

Ideal for screwing in wood. The optimal thread geometry ensures the best grip in a variety of wood materials. By recording TX optimum power transmission is achieved.

### KARAKTERISTIKE

- Djelomični navoj
- okrugla glava
- pojačanje donje glave
- TX šesterokraki zvjezdasti upust
- standardni vrh

### FEATURES

- fullthread
- pan head
- double pan head
- TX drive
- standard tip



## Art. 9045 A2

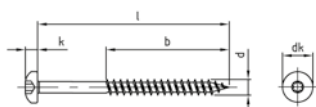

### PRIMJENE

Idealno za zavijčavanje u drvu. Optimalna geometrija navoja osigurava najbolju čvrstoću u različitim drvenim materijalima. TX prihvata omogućava optimalan prijenos snage.

### APPLICATIONS

Ideal for screwing in wood. The optimal thread geometry ensures the best grip in a variety of wood materials. By recording TX optimum power transmission is achieved.

### KARAKTERISTIKE

- Puni navoj
- okrugla glava
- pojačanje donje glave
- šesterokraki zvjezdasti upust
- standardni vrh

### FEATURES

- partial thread
- pan head
- double pan head
- TX drive
- standard tip



## Artikli 9045 A2 TX Vijci okrugle pojačane glave za ugradnju u drvo, djelomični navoj

Item 9045 A2 TX

Double pan head timber screws with partial thread

d	3	3,5	4	4,5	5
l/mm	Kat.-broj/Item no.	Kat.-broj/Item no.	Kat.-broj/Item no.	Kat.-broj/Item no.	Kat.-broj/Item no.
25	9045230 25/18	9045235 25/18	9045240 25/18	9045245 25/18	9045250 25/18
30	9045230 30/18	9045235 30/18	9045240 30/18	9045245 30/18	9045250 30/20
35	9045230 35/24	9045235 35/24	9045240 35/24	9045245 35/24	9045250 35/24
40	9045230 40/24	9045235 40/24	9045240 40/24	9045245 40/24	9045250 40/24
45		9045235 45/30	9045240 45/30	9045245 45/30	9045250 45/30
50		9045235 50/30	9045240 50/30	9045245 50/30	9045250 50/30
55			9045240 55/36	9045245 55/36	9045250 55/36
60			9045240 60/36	9045245 60/36	9045250 60/36
65			9045240 65/42	9045245 65/42	9045250 65/42
70			9045240 70/42	9045245 70/42	9045250 70/42
80				9045245 80/48	9045250 80/48
90					9045250 90/54
100					9045250 100/60
110					
120					

	500	500	500 ≥40: box = 200	500 ≥40: box = 200	500 ≥40: box = 200 ≥60: box = 100
dk	6	7	8	9	10
k	2.5	2.6	3	3.1	3.7
Veličina p Drive size	TX10	TX10	TX20	TX20	TX25

## Artikl 9045 A2 TX

### Vijci okrugle pojačane glave za ugradnju u drvo, djelomični navoj

Art. 9045  
A2

Item 9045 A2 TX

Double pan head timber screws with partial thread

6

Kat.-broj/Item no.

9045260 30/20

9045260 35/24

9045260 40/24

9045260 45/30

9045260 50/30

9045260 55/36

9045260 60/36

9045260 65/42

9045260 70/42

9045260 80/48

9045260 90/54

9045260 100/70

9045260 110/70

9045260 120/70

100

12

4.7

TX25

## Art. 9045 A4

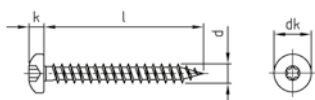

### PRIMJENE

Idealno za zavijčavanje u drvu. Optimalna geometrija navoja osigurava najbolju čvrstoću u različitim drvenim materijalima. TX prihvata omogućava optimalan prijenos snage.

### APPLICATIONS

Ideal for screwing in wood. The optimal thread geometry ensures the best grip in a variety of wood materials. By recording TX optimum power transmission is achieved.

### KARAKTERISTIKE

- Djelomični navoj
- okrugla glava
- pojačanje donje glave
- TX šesterokraki zvjezdasti upust
- standardni vrh

### FEATURES

- fullthread
- pan head
- double pan head
- TX drive
- standard tip



## Artikl 9045 A4 TX Vijci okrugle pojačane glave za ugradnju u drvo, puni navoj

Item 9045 A4 TX

Double pan head timber screws with fullthread

d	3	3,5	4	4,5	5	6
l/mm	Kat.-broj/Item no.	Kat.-broj/Item no.	Kat.-broj/Item no.	Kat.-broj/Item no.	Kat.-broj/Item no.	Kat.-broj/Item no.
10	9045430 10	9045435 10	9045440 10			
12	9045430 12	9045435 12	9045440 12	9045445 12		
16	9045430 16	9045435 16	9045440 16	9045445 16	9045450 16	
20	9045430 20	9045435 20	9045440 20	9045445 20	9045450 20	9045460 20
25	9045430 25	9045435 25	9045440 25	9045445 25	9045450 25	9045460 25
30	9045430 30	9045435 30	9045440 30	9045445 30	9045450 30	9045460 30
35	9045430 35	9045435 35	9045440 35	9045445 35	9045450 35	9045460 35
40	9045430 40	9045435 40	9045440 40	9045445 40	9045450 40	9045460 40
45		9045435 45	9045440 45	9045445 45	9045450 45	9045460 45
50		9045435 50	9045440 50	9045445 50	9045450 50	9045460 50
55			9045440 55	9045445 55	9045450 55	9045460 55
60			9045440 60	9045445 60	9045450 60	9045460 60
65			9045440 65	9045445 65	9045450 65	9045460 65
70			9045440 70	9045445 70	9045450 70	9045460 70
80				9045445 80	9045450 80	9045460 80
90					9045450 90	9045460 90
100					9045450 100	9045460 100
110						9045460 110

	200	200	200	200	200 ≥60: box=100	100
dk	6	7	8	9	10	12
k	2.5	2.6	3	3.1	3.7	4.7
Veličina p Drive size	TX10	TX15	TX20	TX20	TX25	TX25

## Artikl 9045 A4 TX Vijci okrugle pojačane glave za ugradnju u drvo, djelomični navoj

Art. 9045  
A4

Item 9045 A4 TX

Double pan head timber screws with partial thread

d	3	3,5	4	4,5	5
l/mm	Kat.-broj/Item no.	Kat.-broj/Item no.	Kat.-broj/Item no.	Kat.-broj/Item no.	Kat.-broj/Item no.
25	9045430 25/18	9045435 25/18	9045440 25/18	9045445 25/18	9045450 25/18
30	9045430 30/18	9045435 30/18	9045440 30/18	9045445 30/18	9045450 30/20
35	9045430 35/24	9045435 35/24	9045440 35/24	9045445 35/24	9045450 35/24
40	9045430 40/24	9045435 40/24	9045440 40/24	9045445 40/24	9045450 40/24
45		9045435 45/30	9045440 45/30	9045445 45/30	9045450 45/30
50		9045435 50/30	9045440 50/30	9045445 50/30	9045450 50/30
55			9045440 55/36	9045445 55/36	9045450 55/36
60			9045440 60/36	9045445 60/36	9045450 60/36
65			9045440 65/42	9045445 65/42	9045450 65/42
70			9045440 70/42	9045445 70/42	9045450 70/42
80				9045445 80/48	9045450 80/48
90					9045450 90/54
100					9045450 100/60
110					
120					

Više dimenzija na sljedećoj stranici. / Further dimensions on the next page.

	200	200	200	200	200 ≥60: box=100
dk	6	7	8	9	10
k	2.5	2.6	3	3.1	3.7
Veličina p Drive size	TX10	TX15	TX20	TX20	TX25

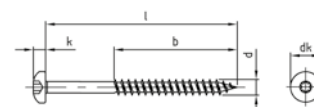

### PRIMJENE

Idealno za zavijčavanje u drvo. Optimalna geometrija navoja osigurava najbolju čvrstoću u različitim drvenim materijalima. TX prihvata omogućava optimalan prijenos snage.

### APPLICATIONS

Ideal for screwing in wood. The optimal thread geometry ensures the best grip in a variety of wood materials. By recording TX optimum power transmission is achieved.

### KARAKTERISTIKE

- Puni navoj
- okrugla glava
- pojačanje donje glave
- šesterokraki zvjezdasti upust
- standardni vrh

### FEATURES

- partial thread
- pan head
- double pan head
- TX drive
- standard tip



## Art. 9045 A4

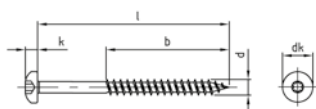

### PRIMJENE

Idealno za zavijčavanje u drvu. Optimalna geometrija navoja osigurava najbolju čvrstoću u različitim drvenim materijalima. TX prihvata omogućava optimalan prijenos snage.

### APPLICATIONS

Ideal for screwing in wood. The optimal thread geometry ensures the best grip in a variety of wood materials. By recording TX optimum power transmission is achieved.

### KARAKTERISTIKE

- Puni navoj
- okrugla glava
- pojačanje donje glave
- šesterokraki zvjezdasti upust
- standardni vrh

### FEATURES

- partial thread
- pan head
- double pan head
- TX drive
- standard tip



## Artikl 9045 A4 TX Vijci okrugle pojačane glave za ugradnju u drvo, djelomični navoj

Item 9045 A4 TX

Double pan head timber screws with partial thread

d	6
l/mm	Kat.-broj/Item no.
25	
30	9045460 30/20
35	9045460 35/24
40	9045460 40/24
45	9045460 45/30
50	9045460 50/30
55	9045460 55/36
60	9045460 60/36
65	9045460 65/42
70	9045460 70/42
80	9045460 80/48
90	9045460 90/54
100	9045460 100/70
110	9045460 110/70
120	9045460 120/70

	100
dk	12
k	4.7
Veličina p Drive size	TX25

## Artikl 9046 A2 TX Vijci lećaste upušć pojaćane glave za stezne ploće, puni navoj

Art. 9046  
A2

Item 9046 A2 TX

Double raised countersunk head timber screws with fullthread

d	3	3,5	4	4,5	5	6
l/mm	Kat.-broj/Item no.	Kat.-broj/Item no.	Kat.-broj/Item no.	Kat.-broj/Item no.	Kat.-broj/Item no.	Kat.-broj/Item no.
10	9046230 10	9046235 10	9046240 10			
12	9046230 12	9046235 12	9046240 12	9046245 12		
16	9046230 16	9046235 16	9046240 16	9046245 16	9046250 16	
20	9046230 20	9046235 20	9046240 20	9046245 20	9046250 20	9046260 20
25	9046230 25	9046235 25	9046240 25	9046245 25	9046250 25	9046260 25
30	9046230 30	9046235 30	9046240 30	9046245 30	9046250 30	9046260 30
35	9046230 35	9046235 35	9046240 35	9046245 35	9046250 35	9046260 35
40	9046230 40	9046235 40	9046240 40	9046245 40	9046250 40	9046260 40
45		9046235 45	9046240 45	9046245 45	9046250 45	9046260 45
50		9046235 50	9046240 50	9046245 50	9046250 50	9046260 50
55			9046240 55	9046245 55	9046250 55	9046260 55
60			9046240 60	9046245 60	9046250 60	9046260 60
65			9046240 65	9046245 65	9046250 65	9046260 65
70			9046240 70	9046245 70	9046250 70	9046260 70
80				9046245 80	9046250 80	9046260 80
90					9046250 90	9046260 90
100					9046250 100	9046260 100

	500	500	500 ≥40: box = 200	500 ≥40: box = 200	500 ≥40: box = 200 ≥60: box = 100	100
dk	6	7	8	9	10	12
k	1.9	2.1	2.5	2.7	3	3.6
Velićina p Drive size	TX10	TX10	TX20	TX20	TX25	TX25

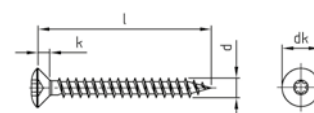

### PRIMJENE

Idealno za zavijćavanje u drvu. Optimalna geometrija navoja osigurava najbolju ćvrstoću u razlićitim drvenim materijalima. TX prihvat omogućava optimalan prijenos snage.

### APPLICATIONS

Ideal for screwing in wood. The optimal thread geometry ensures the best grip in a variety of wood materials. By recording TX optimum power transmission is achieved.

### KARAKTERISTIKE

- Puni navoj
- lećasta upušćena glava
- pojaćanje donje glave
- TX šesterokraki zvjezdasti upust
- standardni vrh

### FEATURES

- fullthread
- raised countersunk head
- double raised countersunk head
- TX drive
- standard tip



## Art. 9046 A2

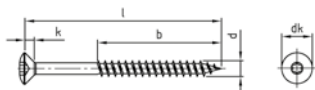

### PRIMJENE

Idealno za zavijčavanje u drvu. Optimalna geometrija navoja osigurava najbolju čvrstoću u različitim drvenim materijalima. TX prihvat omogućava optimalan prijenos snage.

### APPLICATIONS

Ideal for screwing in wood. The optimal thread geometry ensures the best grip in a variety of wood materials. By recording TX optimum power transmission is achieved.

### KARAKTERISTIKE

- djelomični navoj
- lečasta upuštena glava
- pojačanje donje glave
- TX šesterokraki zvjezdasti upust
- standardni vrh

### FEATURES

- partial thread
- raised countersunk head
- double raised countersunk head
- TX drive
- standard tip



## Artikli 9046 A2 TX Vijci lečaste upušć glave za stezne ploče, djelomićni navoj

Item 9046 A2 TX

Double raised countersunk head timber screws with partial thread

d	3	3,5	4	4,5
l/mm	Kat.-broj/Item no.	Kat.-broj/Item no.	Kat.-broj/Item no.	Kat.-broj/Item no.
25	9046230 25/18	9046235 25/18	9046240 25/18	9046245 25/18
30	9046230 30/18	9046235 30/18	9046240 30/18	9046245 30/18
35	9046230 35/24	9046235 35/24	9046240 35/24	9046245 35/24
40	9046230 40/24	9046235 40/24	9046240 40/24	9046245 40/24
45		9046235 45/30	9046240 45/30	9046245 45/30
50		9046235 50/30	9046240 50/30	9046245 50/30
55			9046240 55/36	9046245 55/36
60			9046240 60/36	9046245 60/36
65			9046240 65/42	9046245 65/42
70			9046240 70/42	9046245 70/42
80				9046245 80/48
90				
100				
110				
120				

	500	500	500 ≥40: box = 200	500 ≥40: box = 200
dk	6	7	8	9
k	1.9	2.1	2.5	2.7
Velićina p Drive size	TX10	TX10	TX20	TX20

**Artikl 9046 A2 TX**  
**Vijci lećaste upušć pojaćane glave za stezne ploće, djelomićni navoj**

**Art. 9046**  
**A2**

Item 9046 A2 TX

Double raised countersunk head timber screws with partial thread

5	6
Kat.-broj/Item no.	Kat.-broj/Item no.
9046250 25/18	
9046250 30/20	9046260 30/20
9046250 35/24	9046260 35/24
9046250 40/24	9046260 40/24
9046250 45/30	9046260 45/30
9046250 50/30	9046260 50/30
9046250 55/36	9046260 55/36
9046250 60/36	9046260 60/36
9046250 65/42	9046260 65/42
9046250 70/42	9046260 70/42
9046250 80/48	9046260 80/48
9046250 90/54	9046260 90/54
9046250 100/60	9046260 100/70
	9046260 110/70
	9046260 120/70

500 ≥40: box = 200 ≥60: box = 100	100
10	12
3	3.6
TX25	TX25

## Art. 9046 A4

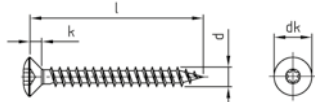

### PRIMJENE

Idealno za zavijčavanje u drvu. Optimalna geometrija navoja osigurava najbolju čvrstoću u različitim drvenim materijalima. TX prihvata omogućava optimalan prijenos snage.

### APPLICATIONS

Ideal for screwing in wood. The optimal thread geometry ensures the best grip in a variety of wood materials. By recording TX optimum power transmission is achieved.

### KARAKTERISTIKE

- Puni navoj
- lečasta upuštena glava
- pojačanje donje glave
- TX šesterokraki zvjezdasti upust
- standardni vrh

### FEATURES

- fullthread
- raised countersunk head
- double raised countersunk head
- TX drive
- standard tip



## Artikl 9046 A4 TX Vijci lečaste upušć glave za stezne ploče, puni navoj

Item 9046 A4 TX

Double raised countersunk head timber screws with fullthread

d	3	3,5	4	4,5	5	6
l/mm	Kat.-broj/Item no.	Kat.-broj/Item no.	Kat.-broj/Item no.	Kat.-broj/Item no.	Kat.-broj/Item no.	Kat.-broj/Item no.
10	9046430 10	9046435 10	9046440 10			
12	9046430 12	9046435 12	9046440 12	9046445 12		
16	9046430 16	9046435 16	9046440 16	9046445 16	9046450 16	
20	9046430 20	9046435 20	9046440 20	9046445 20	9046450 20	9046460 20
25	9046430 25	9046435 25	9046440 25	9046445 25	9046450 25	9046460 25
30	9046430 30	9046435 30	9046440 30	9046445 30	9046450 30	9046460 30
35	9046430 35	9046435 35	9046440 35	9046445 35	9046450 35	9046460 35
40	9046430 40	9046435 40	9046440 40	9046445 40	9046450 40	9046460 40
45		9046435 45	9046440 45	9046445 45	9046450 45	9046460 45
50		9046435 50	9046440 50	9046445 50	9046450 50	9046460 50
55			9046440 55	9046445 55	9046450 55	9046460 55
60			9046440 60	9046445 60	9046450 60	9046460 60
65			9046440 65	9046445 65	9046450 65	9046460 65
70			9046440 70	9046445 70	9046450 70	9046460 70
80				9046445 80	9046450 80	9046460 80
90					9046450 90	9046460 90
100					9046450 100	9046460 100

	200	200	200	200	200 ≥60: box=100	100
dk	6	7	8	9	10	12
k	1.9	2.1	2.5	2.7	3	3.6
Veličina p Drive size	TX10	TX15	TX20	TX20	TX25	TX25

## Artikl 9046 A4 TX Vijci lečaste upušt glave za stezne ploče, djelomični navoj

Art. 9046  
A4

Item 9046 A4 TX

Double raised countersunk head timber screws with partial thread

d	3	3,5	4	4,5	5
l/mm	Kat.-broj/Item no.	Kat.-broj/Item no.	Kat.-broj/Item no.	Kat.-broj/Item no.	Kat.-broj/Item no.
25	9046430 25/18	9046435 25/18	9046440 25/18	9046445 25/18	9046450 25/18
30	9046430 30/18	9046435 30/18	9046440 30/18	9046445 30/18	9046450 30/20
35	9046430 35/24	9046435 35/24	9046440 35/24	9046445 35/24	9046450 35/24
40	9046430 40/24	9046435 40/24	9046440 40/24	9046445 40/24	9046450 40/24
45		9046435 45/30	9046440 45/30	9046445 45/30	9046450 45/30
50		9046435 50/30	9046440 50/30	9046445 50/30	9046450 50/30
55			9046440 55/36	9046445 55/36	9046450 55/36
60			9046440 60/36	9046445 60/36	9046450 60/36
65			9046440 65/42	9046445 65/42	9046450 65/42
70			9046440 70/42	9046445 70/42	9046450 70/42
80				9046445 80/48	9046450 80/48
90					9046450 90/54
100					9046450 100/60
110					
120					

Više dimenzija na sljedećoj stranici. / Further dimensions on the next page.

	200	200	200	200	200 ≥60: box=100
dk	6	7	8	9	10
k	1.9	2.1	2.5	2.7	3
Veličina p Drive size	TX10	TX15	TX20	TX20	TX25

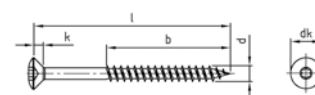

### PRIMJENE

Idealno za zavijčavanje u drvu. Optimalna geometrija navoja osigurava najbolju čvrstoću u različitim drvenim materijalima. TX prihvata omogućava optimalan prijenos snage.

### APPLICATIONS

Ideal for screwing in wood. The optimal thread geometry ensures the best grip in a variety of wood materials. By recording TX optimum power transmission is achieved.

### KARAKTERISTIKE

- Djelomični navoj
- lečasta upuštena glava
- pojačanje donje glave
- TX šesterokraki zvjezdasti upust
- standardni vrh

### FEATURES

- partial thread
- raised countersunk head
- double raised countersunk head
- TX drive
- standard tip



## Art. 9046 A4

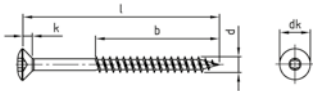

### PRIMJENE

Idealno za zavijčavanje u drvu. Optimalna geometrija navoja osigurava najbolju čvrstoću u različitim drvenim materijalima. TX prihvata omogućava optimalan prijenos snage.

### APPLICATIONS

Ideal for screwing in wood. The optimal thread geometry ensures the best grip in a variety of wood materials. By recording TX optimum power transmission is achieved.

### KARAKTERISTIKE

- Djelomični navoj
- lečasta upuštena glava
- pojačanje donje glave
- TX šesterokraki zvjezdasti upust
- standardni vrh

### FEATURES

- partial thread
- raised countersunk head
- double raised countersunk head
- TX drive
- standard tip



## Artikl 9046 A4 TX Vijci lečaste upušć glave za stezne ploče, djelomićni navoj

Item 9046 A4 TX

Double raised countersunk head timber screws with partial thread

d	6
l/mm	Kat.-broj/Item no.
25	
30	9046460 30/20
35	9046460 35/24
40	9046460 40/24
45	9046460 45/30
50	9046460 50/30
55	9046460 55/36
60	9046460 60/36
65	9046460 65/42
70	9046460 70/42
80	9046460 80/48
90	9046460 90/54
100	9046460 100/70
110	9046460 110/70
120	9046460 120/70

	100
dk	12
k	3.6
Velićina p Drive size	TX25

## Artikl 9047 A2 TX Vijci upuštene pojačane glave za ugradnju u drvo, puni navoj

Art. 9047  
A2

Item 9047 A2 TX

Double countersunk head timber screws with fullthread

d	3	3,5	4	4,5	5	6
l/mm	Kat.-broj/Item no.	Kat.-broj/Item no.	Kat.-broj/Item no.	Kat.-broj/Item no.	Kat.-broj/Item no.	Kat.-broj/Item no.
10	9047230 10	9047235 10	9047240 10			
12	9047230 12	9047235 12	9047240 12	9047245 12		
16	9047230 16	9047235 16	9047240 16	9047245 16	9047250 16	
20	9047230 20	9047235 20	9047240 20	9047245 20	9047250 20	9047260 20
25	9047230 25	9047235 25	9047240 25	9047245 25	9047250 25	9047260 25
30	9047230 30	9047235 30	9047240 30	9047245 30	9047250 30	9047260 30
35	9047230 35	9047235 35	9047240 35	9047245 35	9047250 35	9047260 35
40	9047230 40	9047235 40	9047240 40	9047245 40	9047250 40	9047260 40
45	9047230 45	9047235 45	9047240 45	9047245 45	9047250 45	9047260 45
50	9047230 50	9047235 50	9047240 50	9047245 50	9047250 50	9047260 50
55			9047240 55	9047245 55	9047250 55	9047260 55
60			9047240 60	9047245 60	9047250 60	9047260 60
65			9047240 65	9047245 65	9047250 65	9047260 65
70			9047240 70	9047245 70	9047250 70	9047260 70
80			9047240 80	9047245 80	9047250 80	9047260 80
90				9047245 90	9047250 90	9047260 90
100				9047245 100	9047250 100	9047260 100

Više dimenzija na sljedećoj stranici. / Further dimensions on the next page.

	500 ≥40: box = 200	500 ≥40: box = 200	500 ≥40: box = 200	500 ≥40: box = 200	500 ≥40: box = 200 ≥60: box = 100	100
dk	6	7	8	9	10	12
k	1.9	2.1	2.5	2.7	3	3.6
Veličina p Drive size	TX10	TX10	TX20	TX20	TX25	TX25

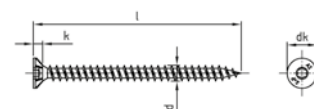

### PRIMJENE

Idealno za zavijčavanje u drvo. Optimalna geometrija navoja osigurava najbolju čvrstoću u različitim drvenim materijalima. TX prihvat omogućava optimalan prijenos snage.

### APPLICATIONS

Ideal for screwing in wood. The optimal thread geometry ensures the best grip in a variety of wood materials. By recording TX optimum power transmission is achieved.

### KARAKTERISTIKE

- Puni navoj
- upuštena glava 90°
- pojačanje donje glave
- TX šesterokraki zvjezdasti upust
- standardni vrh
- od promjera 10, 8 i od 6 x 140 mm rebra za glodanje ispod glave

### FEATURES

- fullthread
- countersunk 90°
- double countersunk head
- TX drive
- standard tip
- at Diameter 10, 8 and at 6 x 140mm ribs under the head



**Art. 9047  
A2**

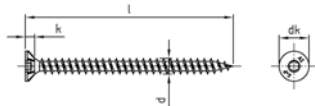

**PRIMJENE**

Idealno za zavijčavanje u drvu. Optimalna geometrija navoja osigurava najbolju čvrstoću u različitim drvenim materijalima. TX prihvat omogućava optimalan prijenos snage.

**APPLICATIONS**

Ideal for screwing in wood. The optimal thread geometry ensures the best grip in a variety of wood materials. By recording TX optimum power transmission is achieved.

**KARAKTERISTIKE**

- Puni navoj
- upuštena glava 90°
- pojačanje donje glave
- TX šesterokraki zvjezdasti upust
- standardni vrh
- od promjera 10, 8 i od 6 x 140 mm rebra za glodanje ispod glave

**FEATURES**

- fullthread
- countersunk 90°
- double countersunk head
- TX drive
- standard tip
- at Diameter 10, 8 and at 6 x 140mm ribs under the head



**Artikl 9047 A2 TX  
Vijci upuštene pojačane glave za ugradnju u drvo, puni navoj**

Item 9047 A2 TX

Double countersunk head timber screws with fullthread

d	8	10
l/mm	Kat.-broj/Item no.	Kat.-broj/Item no.
10		
12		
16		
20		
25		
30	9047280 30	
35		
40	9047280 40	
45		
50	9047280 50	
55		
60	9047280 60	
65		
70	9047280 70	90472100 70
80	9047280 80	90472100 80
90	9047280 90	90472100 90
100	9047280 100	90472100 100

	100	100
dk	15	19
k	4.1	4.7
Veličina p Drive size	TX40	TX40

## Artikl 9047 A2 TX Vijci upuštene pojačane glave za ugradnju u drvo, djelomični navoj

Art. 9047  
A2

Item 9047 A2 TX

Double countersunk head timber screws with partial thread

d	3	3,5	4	4,5	5
l/mm	Kat.-broj/Item no.	Kat.-broj/Item no.	Kat.-broj/Item no.	Kat.-broj/Item no.	Kat.-broj/Item no.
25	9047230 25/18	9047235 25/18	9047240 25/18	9047245 25/18	9047250 25/18
30	9047230 30/18	9047235 30/18	9047240 30/18	9047245 30/18	9047250 30/20
35	9047230 35/24	9047235 35/24	9047240 35/24	9047245 35/24	9047250 35/24
40	9047230 40/24	9047235 40/24	9047240 40/24	9047245 40/24	9047250 40/24
45	9047230 45/30	9047235 45/30	9047240 45/30	9047245 45/30	9047250 45/30
50	9047230 50/30	9047235 50/30	9047240 50/30	9047245 50/30	9047250 50/30
55			9047240 55/36	9047245 55/36	9047250 55/36
60			9047240 60/36	9047245 60/36	9047250 60/36
65			9047240 65/36	9047245 65/42	9047250 65/36
70			9047240 70/42	9047245 70/42	9047250 70/42
80			9047240 80/48	9047245 80/48	9047250 80/48
90				9047245 90/54	9047250 90/54
100				9047245 100/60	9047250 100/60
110					9047250 110/70
120					9047250 120/70
130					
140					
150					
160					
170					
180					
190					
200					
220					
225					
240					
250					
260					
280					
300					
320					
325					
340					
350					
360					
375					
380					
400					

Više dimenzija na sljedećoj stranici. / Further dimensions on the next page.

	500 ≥40: box = 200	500 ≥40: box = 200	500 ≥40: box = 200	500 ≥40: box = 200	500 ≥40: box = 200 ≥60: box = 100
dk	6	7	8	9	10
k	1,9	2,1	2,5	2,7	3
Veličina p Drive size	TX10	TX10	TX20	TX20	TX25

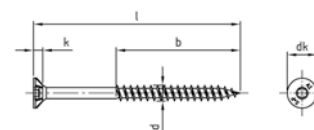

### PRIMJENE

Idealno za zavijčavanje u drvo. Optimalna geometrija navoja osigurava najbolju čvrstoću u različitim drvenim materijalima. TX prihvata omogućava optimalan prijenos snage.

### APPLICATIONS

Ideal for screwing in wood. The optimal thread geometry ensures the best grip in a variety of wood materials. By recording TX optimum power transmission is achieved.

### KARAKTERISTIKE

- Djelomični navoj
- upuštena glava 90°
- pojačanje donje glave
- TX šesterokraki zvjezdasti upust
- standardni vrh
- od promjera 10, 8 i od 6 x 140 mm rebra za glodanje ispod glave

### FEATURES

- partial thread
- countersunk 90°
- double countersunk head
- TX drive
- standard tip
- at Diameter 10, 8 and at 6 x 140mm ribs under the head



**Art. 9047  
A2**

**Artikl 9047 A2 TX  
Vijci upuštene pojačane glave za ugradnju u drvo, djelomični navoj**

Item 9047 A2 TX  
Double countersunk head timber screws with partial thread

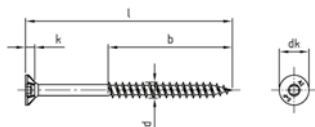

**PRIMJENE**

Idealno za zavijčavanje u drvo. Optimalna geometrija navoja osigurava najbolju čvrstoću u različitim drvenim materijalima. TX prihvat omogućava optimalan prijenos snage.

**APPLICATIONS**

Ideal for screwing in wood. The optimal thread geometry ensures the best grip in a variety of wood materials. By recording TX optimum power transmission is achieved.

**KARAKTERISTIKE**

- Djelomični navoj
- upuštena glava 90°
- pojačanje donje glave
- TX šesterokraki zvjezdasti upust
- standardni vrh
- od promjera 10, 8 i od 6 x 140 mm rebra za glodanje ispod glave

**FEATURES**

- partial thread
- countersunk 90°
- double countersunk head
- TX drive
- standard tip
- at Diameter 10, 8 and at 6 x 140mm ribs under the head



d	6	8	10
l/mm	Kat.-broj/Item no.	Kat.-broj/Item no.	Kat.-broj/Item no.
25			
30	9047260 30/20		
35	9047260 35/24		
40	9047260 40/24		
45	9047260 45/30		
50	9047260 50/30		
55	9047260 55/36		
60	9047260 60/36		90472100 60/50
65	9047260 65/42		
70	9047260 70/42	9047280 70/50	90472100 70/55
80	9047260 80/48	9047280 80/50	90472100 80/55
90	9047260 90/54	9047280 90/60	90472100 90/55
100	9047260 100/70	9047280 100/80	90472100 100/55
110	9047260 110/70	9047280 110/80	90472100 110/80
120	9047260 120/70	9047280 120/80	90472100 120/80
130	9047260 130/70	9047280 130/80	90472100 130/80
140	9047260 140/70	9047280 140/80	90472100 140/80
150	9047260 150/70	9047280 150/80	90472100 150/80
160	9047260 160/70	9047280 160/80	90472100 160/80
170	9047260 170/70	9047280 170/80	90472100 170/80
180	9047260 180/70	9047280 180/80	90472100 180/105
190	9047260 190/70	9047280 190/80	90472100 190/105
200	9047260 200/70	9047280 200/80	90472100 200/105
220	9047260 220/70	9047280 220/80	90472100 220/105
225		9047280 225/80	
240	9047260 240/70	9047280 240/80	90472100 240/105
250		9047280 250/80	
260	9047260 260/70	9047280 260/80	90472100 260/105
280	9047260 280/70	9047280 280/80	90472100 280/105
300	9047260 300/70	9047280 300/80	90472100 300/105
320		9047280 320/80	90472100 320/105
325		9047280 325/80	
340		9047280 340/80	90472100 340/105
350		9047280 350/80	
360		9047280 360/80	90472100 360/105
375		9047280 375/80	90472100 375/105
380		9047280 380/80	
400		9047280 400/80	90472100 400/105

	100	100	100 ≥340: box = 50
dk	12	15	19
k	3.6	4.1	4.7
Veličina p Drive size	TX25	TX40	TX40

## Artikli 9047 A4 TX Vijci upuštene pojačane glave za ugradnju u drvo, puni navoj

Art. 9047  
A4

Item 9047 A4 TX

Double countersunk head timber screws with fullthread

d	3	3,5	4	4,5	5	6
l/mm	Kat.-broj/Item no.	Kat.-broj/Item no.	Kat.-broj/Item no.	Kat.-broj/Item no.	Kat.-broj/Item no.	Kat.-broj/Item no.
10	9047430 10	9047435 10	9047440 10			
12	9047430 12	9047435 12	9047440 12	9047445 12		
16	9047430 16	9047435 16	9047440 16	9047445 16	9047450 16	
20	9047430 20	9047435 20	9047440 20	9047445 20	9047450 20	9047460 20
25	9047430 25	9047435 25	9047440 25	9047445 25	9047450 25	9047460 25
30	9047430 30	9047435 30	9047440 30	9047445 30	9047450 30	9047460 30
35	9047430 35	9047435 35	9047440 35	9047445 35	9047450 35	9047460 35
40	9047430 40	9047435 40	9047440 40	9047445 40	9047450 40	9047460 40
45	9047430 45	9047435 45	9047440 45	9047445 45	9047450 45	9047460 45
50	9047430 50	9047435 50	9047440 50	9047445 50	9047450 50	9047460 50
55			9047440 55	9047445 55	9047450 55	9047460 55
60			9047440 60	9047445 60	9047450 60	9047460 60
65			9047440 65	9047445 65	9047450 65	9047460 65
70			9047440 70	9047445 70	9047450 70	9047460 70
80			9047440 80	9047445 80	9047450 80	9047460 80
90				9047445 90	9047450 90	9047460 90
100				9047445 100	9047450 100	9047460 100

Više dimenzija na sljedećoj stranici. / Further dimensions on the next page.

	500 ≥40: box=200	200	200	200	200 ≥60: box=100	100
dk	6	7	8	9	10	12
k	1.9	2.1	2.5	2.7	3	3.6
Veličina p Drive size	TX10	TX15	TX20	TX20	TX25	TX25

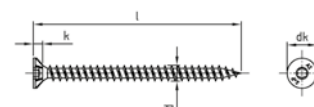

### PRIMJENE

Idealno za zavijčavanje u drvo. Optimalna geometrija navoja osigurava najbolju čvrstoću u različitim drvenim materijalima. TX prihvat omogućava optimalan prijenos snage.

### APPLICATIONS

Ideal for screwing in wood. The optimal thread geometry ensures the best grip in a variety of wood materials. By recording TX optimum power transmission is achieved.

### KARAKTERISTIKE

- S punim navojem
- upuštena glava 90°
- pojačanje donje glave
- TX šesterokraki zvjezdasti upust
- standardni vrh
- od promjera 10, 8 i od 6 x 140 mm rebra za glodanje ispod glave

### FEATURES

- fullthread
- countersunk 90°
- double countersunk head
- TX drive
- standard tip
- at Diameter 10, 8 and at 6 x 140mm ribs under the head



**Art. 9047  
A4**

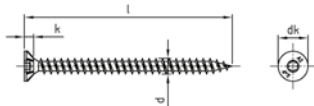

**PRIMJENE**

Idealno za zavijčavanje u drvu. Optimalna geometrija navoja osigurava najbolju čvrstoću u različitim drvenim materijalima. TX prihvat omogućava optimalan prijenos snage.

**APPLICATIONS**

Ideal for screwing in wood. The optimal thread geometry ensures the best grip in a variety of wood materials. By recording TX optimum power transmission is achieved.

**KARAKTERISTIKE**

- S punim navojem
- upuštena glava 90°
- pojačanje donje glave
- TX šesterokraki zvjezdasti upust
- standardni vrh
- od promjera 10, 8 i od 6 x 140 mm rebra za glodanje ispod glave

**FEATURES**

- fullthread
- countersunk 90°
- double countersunk head
- TX drive
- standard tip
- at Diameter 10, 8 and at 6 x 140mm ribs under the head



**Artikl 9047 A4 TX  
Vijci upuštene pojačane glave za ugradnju u drvo, puni navoj**

Item 9047 A4 TX

Double countersunk head timber screws with fullthread

d	8	10
l/mm	Kat.-broj/Item no.	Kat.-broj/Item no.
10		
12		
16		
20		
25		
30	9047480 30	
35		
40	9047480 40	
45		
50	9047480 50	
55		
60	9047480 60	90474100 60
65		
70	9047480 70	90474100 70
80	9047480 80	90474100 80
90	9047480 90	90474100 90
100	9047480 100	90474100 100

	100	100
dk	15	19
k	4.1	4.7
Veličina p Drive size	TX40	TX40

## Artikl 9047 A4 TX Vijci upuštene pojačane glave za ugradnju u drvo, djelomični navoj

Art. 9047  
A4

Item 9047 A4 TX

Double countersunk head timber screws with partial thread

d	3	3,5	4	4,5	5
l/mm	Kat.-broj/Item no.	Kat.-broj/Item no.	Kat.-broj/Item no.	Kat.-broj/Item no.	Kat.-broj/Item no.
25	9047430 25/18	9047435 25/18	9047440 25/18	9047445 25/18	9047450 25/18
30	9047430 30/18	9047435 30/18	9047440 30/18	9047445 30/18	9047450 30/20
35	9047430 35/24	9047435 35/24	9047440 35/24	9047445 35/24	9047450 35/24
40	9047430 40/24	9047435 40/24	9047440 40/24	9047445 40/24	9047450 40/24
45	9047430 45/30	9047435 45/30	9047440 45/30	9047445 45/30	9047450 45/30
50	9047430 50/30	9047435 50/30	9047440 50/30	9047445 50/30	9047450 50/30
55			9047440 55/36	9047445 55/36	9047450 55/36
60			9047440 60/36	9047445 60/36	9047450 60/36
65			9047440 65/42	9047445 65/42	9047450 65/42
70			9047440 70/42	9047445 70/42	9047450 70/42
80			9047440 80/48	9047445 80/48	9047450 80/48
90				9047445 90/54	9047450 90/54
100				9047445 100/60	9047450 100/60
110					9047450 110/70
120					9047450 120/70
130					
140					
150					
160					
170					
180					
190					
200					
220					
225					
240					
250					
260					
280					
300					
320					
325					
340					
350					
360					
375					
380					
400					

Više dimenzija na sljedećoj stranici. / Further dimensions on the next page.

	500 ≥40: box=200	200	200	200	200	200 ≥60: box=100
dk	6	7	8	9	10	
k	1.9	2.1	2.5	2.7	3	
Veličina p Drive size	TX10	TX15	TX20	TX20	TX25	

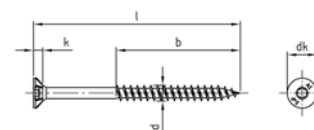

### PRIMJENE

Idealno za zavijčavanje u drvo. Optimalna geometrija navoja osigurava najbolju čvrstoću u različitim drvenim materijalima. TX prihvata omogućava optimalan prijenos snage.

### APPLICATIONS

Ideal for screwing in wood. The optimal thread geometry ensures the best grip in a variety of wood materials. By recording TX optimum power transmission is achieved.

### KARAKTERISTIKE

- Djelomični navoj
- upuštena glava 90°
- pojačanje donje glave
- TX šesterokraki zvjezdasti upust
- standardni vrh
- od promjera 10, 8 i od 6 x 140 mm rebra za glodanje ispod glave

### FEATURES

- partial thread
- countersunk 90°
- double countersunk head
- TX drive
- standard tip
- at Diameter 10, 8 and at Diameter 6 x 140mm ribs under the head



**Art. 9047  
A4**

**Artikl 9047 A4 TX  
Vijci upuštene pojačane glave za ugradnju u drvo, djelomični navoj**

Item 9047 A4 TX  
Double countersunk head timber screws with partial thread

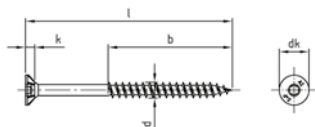

**PRIMJENE**

Idealno za zavijčavanje u drvo. Optimalna geometrija navoja osigurava najbolju čvrstoću u različitim drvenim materijalima. TX prihvat omogućava optimalan prijenos snage.

**APPLICATIONS**

Ideal for screwing in wood. The optimal thread geometry ensures the best grip in a variety of wood materials. By recording TX optimum power transmission is achieved.

**KARAKTERISTIKE**

- Djelomični navoj
- upuštena glava 90°
- pojačanje donje glave
- TX šesterokraki zvjezdasti upust
- standardni vrh
- od promjera 10, 8 i od 6 x 140 mm rebra za glodanje ispod glave

**FEATURES**

- partial thread
- countersunk 90°
- double countersunk head
- TX drive
- standard tip
- at Diameter 10, 8 and at Diameter 6 x 140mm ribs under the head



d	6	8	10
l/mm	Kat.-broj/Item no.	Kat.-broj/Item no.	Kat.-broj/Item no.
25			
30	9047460 30/20		
35	9047460 35/24		
40	9047460 40/24		
45	9047460 45/30		
50	9047460 50/30		
55	9047460 55/36		
60	9047460 60/36		90474100 60/50
65	9047460 65/42		
70	9047460 70/42	9047480 70/50	90474100 70/55
80	9047460 80/48	9047480 80/50	90474100 80/55
90	9047460 90/54	9047480 90/60	90474100 90/55
100	9047460 100/70	9047480 100/80	90474100 100/55
110	9047460 110/70	9047480 110/80	90474100 110/80
120	9047460 120/70	9047480 120/80	90474100 120/80
130	9047460 130/70	9047480 130/80	90474100 130/80
140	9047460 140/70	9047480 140/80	90474100 140/80
150	9047460 150/70	9047480 150/80	90474100 150/80
160	9047460 160/70	9047480 160/80	90474100 160/80
170	9047460 170/70	9047480 170/80	90474100 170/80
180	9047460 180/70	9047480 180/80	90474100 180/105
190	9047460 190/70	9047480 190/80	90474100 190/105
200	9047460 200/70	9047480 200/80	90474100 200/105
220	9047460 220/70	9047480 220/80	90474100 220/105
225		9047480 225/80	
240	9047460 240/70	9047480 240/80	90474100 240/105
250		9047480 250/80	
260	9047460 260/70	9047480 260/80	90474100 260/105
280	9047460 280/70	9047480 280/80	90474100 280/105
300	9047460 300/70	9047480 300/80	90474100 300/105
320		9047480 320/80	90474100 320/105
325		9047480 325/80	
340		9047480 340/80	90474100 340/105
350		9047480 350/80	
360		9047480 360/80	90474100 360/105
375		9047480 375/80	90474100 375/105
380		9047480 380/80	
400		9047480 400/80	90474100 400/105

	100	100	100 ≥340: box=50
dk	12	15	19
k	3.6	4.1	4.7
Veličina p Drive size	TX25	TX40	TX40

## Art. 9147 1.4006

### Vijci s upušt. glavom za drvo s rebrima i urezom

Item 9147 1.4006 TX

Double CSK head timber screws with ribs, cutting point

Art. 9147

C1

d	3	3,5	4	4,5
l/mm	Kat.-broj/Item no.	Kat.-broj/Item no.	Kat.-broj/Item no.	Kat.-broj/Item no.
12	9147400630 12	9147400635 12	9147400640 12	9147400645 12
16	9147400630 16	9147400635 16	9147400640 16	9147400645 16
20	9147400630 20	9147400635 20	9147400640 20	9147400645 20
25	9147400630 25/18	9147400635 25/18	9147400640 25/18	9147400645 25/18
30	9147400630 30/18	9147400635 30/18	9147400640 30/18	9147400645 30/18
35	9147400630 35/24	9147400635 35/24	9147400640 35/24	9147400645 35/24
40	9147400630 40/24	9147400635 40/24	9147400640 40/24	9147400645 40/24
45	9147400630 45/30	9147400635 45/30	9147400640 45/30	9147400645 45/30
50	9147400630 50/30	9147400635 50/30	9147400640 50/30	9147400645 50/30
55			9147400640 55/36	9147400645 55/36
60			9147400640 60/36	9147400645 60/36
65			9147400640 65/36	9147400645 65/36
70			9147400640 70/42	9147400645 70/42
80			9147400640 80/48	9147400645 80/48
90				9147400645 90/54
100				9147400645 100/60
110				
120				
130				
140				
150				
160				
170				
180				
190				
200				
220				
225				
240				
260				
280				
300				
320				
325				
340				
350				
360				
375				
400				

Više dimenzija na sljedećoj stranici. / Further dimensions on the next page.

	500 ≥40: box = 200	500 ≥40: box = 200	500 ≥40: box = 200	500 ≥40: box = 200
dk	6	7	8	9
k	1.9	2.1	2.5	2.7
Veličina p Drive size	TX10	TX10	TX20	TX20

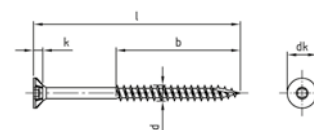

#### PRIMJENE

Idealno za zavijčavanje u drvu. Optimalna geometrija navoja osigurava najbolju čvrstoću u različitim drvenim materijalima. TX prihvat omogućava optimalan prijenos snage.

#### APPLICATIONS

Ideal for screwing in wood. The optimal thread geometry ensures the best grip in a variety of wood materials. By recording TX optimum power transmission is achieved.

#### KARAKTERISTIKE

- Upuštena glava 90°
- pojačanje donje glave
- TX šesterokraki zvjezdasti upust
- vrh za rezanje
- rebra za guljenje ispod glave

#### FEATURES

- countersunk 90°
- double countersunk head
- TX drive
- cutting point
- ribs under the head



## Art. 9147 C1

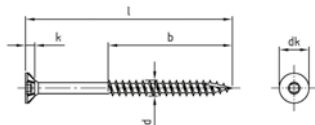

### PRIMJENE

Idealno za zavijčavanje u drvu. Optimalna geometrija navoja osigurava najbolju čvrstoću u različitim drvenim materijalima. TX prihvat omogućava optimalan prijenos snage.

### APPLICATIONS

Ideal for screwing in wood. The optimal thread geometry ensures the best grip in a variety of wood materials. By recording TX optimum power transmission is achieved.

### KARAKTERISTIKE

- Upuštena glava 90°
- pojačanje donje glave
- TX šesterokraki zvjezdasti upust
- vrh za rezanje
- rebra za guljenje ispod glave

### FEATURES

- countersunk 90°
- double countersunk head
- TX drive
- cutting point
- ribs under the head



## Art. 9147 1.4006 Vijci s upušt. glavom za drvo s rebrima i urezom

Item 9147 1.4006 TX

Double CSK head timber screws with ribs, cutting point

d	5	6	8	10
l/mm	Kat.-broj/Item no.	Kat.-broj/Item no.	Kat.-broj/Item no.	Kat.-broj/Item no.
12				
16	9147400650 16			
20	9147400650 20	9147400660 20		
25	9147400650 25/18	9147400660 25		
30	9147400650 30/20	9147400660 30/20	9147400680 30	
35	9147400650 35/24	9147400660 35/24		
40	9147400650 40/24	9147400660 40/24	9147400680 40	
45	9147400650 45/30	9147400660 45/30		
50	9147400650 50/30	9147400660 50/30	9147400680 50	
55	9147400650 55/36	9147400660 55/36		
60	9147400650 60/36	9147400660 60/36	9147400680 60	91474006100 60/50
65	9147400650 65/36	9147400660 65/36		
70	9147400650 70/42	9147400660 70/42	9147400680 70/50	91474006100 70/55
80	9147400650 80/48	9147400660 80/48	9147400680 80/50	91474006100 80/55
90	9147400650 90/54	9147400660 90/54	9147400680 90/60	91474006100 90/55
100	9147400650 100/60	9147400660 100/70	9147400680 100/80	91474006100 100/55
110		9147400660 110/70	9147400680 110/80	91474006100 110/80
120	9147400650 120/70	9147400660 120/70	9147400680 120/80	91474006100 120/80
130		9147400660 130/70	9147400680 130/80	91474006100 130/80
140		9147400660 140/70	9147400680 140/80	91474006100 140/80
150		9147400660 150/70	9147400680 150/80	91474006100 150/80
160		9147400660 160/70	9147400680 160/80	91474006100 160/80
170		9147400660 170/70	9147400680 170/80	91474006100 170/80
180		9147400660 180/70	9147400680 180/80	91474006100 180/105
190		9147400660 190/70	9147400680 190/80	91474006100 190/105
200		9147400660 200/70	9147400680 200/80	91474006100 200/105
220		9147400660 220/70	9147400680 220/80	91474006100 220/105
225			9147400680 225/80	
240		9147400660 240/70	9147400680 240/80	91474006100 240/105
260		9147400660 260/70	9147400680 260/80	91474006100 260/105
280		9147400660 280/70	9147400680 280/80	91474006100 280/105
300		9147400660 300/70	9147400680 300/80	91474006100 300/105
320				91474006100 320/105
325			9147400680 325/80	
340				91474006100 340/105
350			9147400680 350/80	
360			9147400680 360/80	91474006100 360/105
375				91474006100 375/105
400			9147400680 400/80	91474006100 400/105

	500 ≥40: box = 200 ≥60: box = 100	100	100	100 ≥340: box = 50
dk	10	12	15	19
k	3	3.6	4.1	4.7
Veličina p Drive size	TX25	TX25	TX40	TX40

## Artikli 9147 A2 TX Vijci s upušt. glavom za drvo s rebrima i urezom

Art. 9147  
A2

Item 9147 A2 TX

Double CSK head timber screws with ribs, cutting point

d	3	3,5	4	4,5	5
l/mm	Kat.-broj/Item no.	Kat.-broj/Item no.	Kat.-broj/Item no.	Kat.-broj/Item no.	Kat.-broj/Item no.
12	9147230 12	9147235 12	9147240 12	9147245 12	
16	9147230 16	9147235 16	9147240 16	9147245 16	9147250 16
20	9147230 20	9147235 20	9147240 20	9147245 20	9147250 20
25	9147230 25/18	9147235 25/18	9147240 25/18	9147245 25/18	9147250 25/18
30	9147230 30/18	9147235 30/18	9147240 30/18	9147245 30/18	9147250 30/20
35	9147230 35/24	9147235 35/24	9147240 35/24	9147245 35/24	9147250 35/24
40	9147230 40/24	9147235 40/24	9147240 40/24	9147245 40/24	9147250 40/24
45	9147230 45/30	9147235 45/30	9147240 45/30	9147245 45/30	9147250 45/30
50	9147230 50/30	9147235 50/30	9147240 50/30	9147245 50/30	9147250 50/30
55			9147240 55/36	9147245 55/36	9147250 55/36
60			9147240 60/36	9147245 60/36	9147250 60/36
65			9147240 65/36	9147245 65/36	9147250 65/36
70			9147240 70/42	9147245 70/42	9147250 70/42
80			9147240 80/48	9147245 80/48	9147250 80/48
90				9147245 90/54	9147250 90/54
100				9147245 100/60	9147250 100/60
110					
120					9147250 120/70
130					
140					
150					
160					
170					
180					
190					
200					
220					
240					
250					
260					
280					
300					
320					
340					
350					
360					
380					
400					

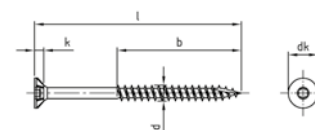

### PRIMJENE

Idealno za zavijčavanje u drvu. Optimalna geometrija navoja osigurava najbolju čvrstoću u različitim drvenim materijalima. TX prihvat omogućava optimalan prijenos snage.

### APPLICATIONS

Ideal for screwing in wood. The optimal thread geometry ensures the best grip in a variety of wood materials. By recording TX optimum power transmission is achieved.

### KARAKTERISTIKE

- Upuštena glava 90°
- pojačanje donje glave
- TX šesterokraki zvjezdasti upust
- vrh za rezanje
- rebra za guljenje ispod glave

### FEATURES

- countersunk 90°
- double countersunk head
- TX drive
- cutting point
- ribs under the head



Više dimenzija na sljedećoj stranici. / Further dimensions on the next page.

	500 ≥40: box=200	500 ≥40: box=200	500 ≥40: box=200	500 ≥40: box=200	500 ≥40: box=200 ≥60: box=100
dk	6	7	8	9	10
k	1,9	2,1	2,5	2,7	3
Veličina p Drive size	TX10	TX10	TX20	TX20	TX25

**Art. 9147  
A2**

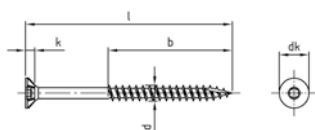

**PRIMJENE**

Idealno za zavijčavanje u drvu. Optimalna geometrija navoja osigurava najbolju čvrstoću u različitim drvenim materijalima. TX prihvat omogućava optimalan prijenos snage.

**APPLICATIONS**

Ideal for screwing in wood. The optimal thread geometry ensures the best grip in a variety of wood materials. By recording TX optimum power transmission is achieved.

**KARAKTERISTIKE**

- Upuštena glava 90°
- pojačanje donje glave
- TX šesterokraki zvjezdasti upust
- vrh za rezanje
- rebra za guljenje ispod glave

**FEATURES**

- countersunk 90°
- double countersunk head
- TX drive
- cutting point
- ribs under the head



**Artikl 9147 A2 TX  
Vijci s upušt. glavom za drvo s rebrima i urezom**

Item 9147 A2 TX

Double CSK head timber screws with ribs, cutting point

d	6	8	10
l/mm	Kat.-broj/Item no.	Kat.-broj/Item no.	Kat.-broj/Item no.
12			
16			
20	9147260 20		
25	9147260 25		
30	9147260 30/20	9147280 30	
35	9147260 35/24		
40	9147260 40/24	9147280 40	
45	9147260 45/30		
50	9147260 50/30	9147280 50	
55	9147260 55/36		
60	9147260 60/36	9147280 60	91472100 60/50
65	9147260 65/36		
70	9147260 70/42	9147280 70/50	91472100 70/55
80	9147260 80/48	9147280 80/50	91472100 80/55
90	9147260 90/54	9147280 90/60	91472100 90/55
100	9147260 100/70	9147280 100/80	91472100 100/55
110	9147260 110/70	9147280 110/80	91472100 110/80
120	9147260 120/70	9147280 120/80	91472100 120/80
130	9147260 130/70	9147280 130/80	91472100 130/80
140	9147260 140/70	9147280 140/80	91472100 140/80
150	9147260 150/70	9147280 150/80	91472100 150/80
160	9147260 160/70	9147280 160/80	91472100 160/80
170	9147260 170/70	9147280 170/80	91472100 170/80
180	9147260 180/70	9147280 180/80	91472100 180/105
190	9147260 190/70	9147280 190/80	91472100 190/105
200	9147260 200/70	9147280 200/80	91472100 200/105
220	9147260 220/70	9147280 220/80	91472100 220/105
240	9147260 240/70	9147280 240/80	91472100 240/105
250		9147280 250/80	
260	9147260 260/70	9147280 260/80	91472100 260/105
280	9147260 280/70	9147280 280/80	91472100 280/105
300	9147260 300/70	9147280 300/80	91472100 300/105
320		9147280 320/80	91472100 320/105
340		9147280 340/80	91472100 340/105
350		9147280 350/80	
360		9147280 360/80	91472100 360/105
380		9147280 380/80	
400		9147280 400/80	91472100 400/105

	100	100	100 ≥340: box = 50
dk	12	15	19
k	3.6	4.1	4.7
Veličina p Drive size	TX25	TX40	TX40

## Artikli 9147 A4 TX Vijci s upušt. glavom za drvo s rebrima i urezom

Art. 9147  
A4

Item 9147 A4 TX

Double CSK head timber screws with ribs, cutting point

d	3	3,5	4	4,5	5
l/mm	Kat.-broj/Item no.	Kat.-broj/Item no.	Kat.-broj/Item no.	Kat.-broj/Item no.	Kat.-broj/Item no.
12	9147430 12	9147435 12	9147440 12	9147445 12	
16	9147430 16	9147435 16	9147440 16	9147445 16	9147450 16
20	9147430 20	9147435 20	9147440 20	9147445 20	9147450 20
25	9147430 25/18	9147435 25/18	9147440 25/18	9147445 25/18	9147450 25/18
30	9147430 30/18	9147435 30/18	9147440 30/18	9147445 30/18	9147450 30/20
35	9147430 35/24	9147435 35/24	9147440 35/24	9147445 35/24	9147450 35/24
40	9147430 40/24	9147435 40/24	9147440 40/24	9147445 40/24	9147450 40/24
45	9147430 45/30	9147435 45/30	9147440 45/30	9147445 45/30	9147450 45/30
50	9147430 50/30	9147435 50/30	9147440 50/30	9147445 50/30	9147450 50/30
55			9147440 55/36	9147445 55/36	9147450 55/36
60			9147440 60/36	9147445 60/36	9147450 60/36
65			9147440 65/36	9147445 65/36	9147450 65/36
70			9147440 70/42	9147445 70/42	9147450 70/42
80			9147440 80/48	9147445 80/48	9147450 80/48
90				9147445 90/54	9147450 90/54
100				9147445 100/60	9147450 100/60
110					
120					9147450 120/70
130					
140					
150					
160					
170					
180					
190					
200					
220					
240					
250					
260					
280					
300					
320					
340					
350					
360					
380					
400					

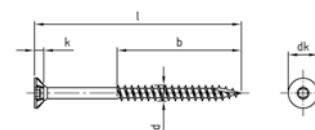

### PRIMJENE

Idealno za zavijčavanje u drvu. Optimalna geometrija navoja osigurava najbolju čvrstoću u različitim drvenim materijalima. TX prihvat omogućava optimalan prijenos snage.

### APPLICATIONS

Ideal for screwing in wood. The optimal thread geometry ensures the best grip in a variety of wood materials. By recording TX optimum power transmission is achieved.

### KARAKTERISTIKE

- Upuštena glava 90°
- pojačanje donje glave
- TX šesterokraki zvjezdasti upust
- vrh za rezanje
- rebra za guljenje ispod glave

### FEATURES

- countersunk 90°
- double countersunk head
- TX drive
- cutting point
- ribs under the head



Više dimenzija na sljedećoj stranici. / Further dimensions on the next page.

	500 ≥40: box = 200	500 ≥40: box = 200	500 ≥40: box = 200	500 ≥40: box = 200	500 ≥40: box = 200 ≥60: box = 100
dk	6	7	8	9	10
k	1,9	2,1	2,5	2,7	3
Veličina p Drive size	TX10	TX10	TX20	TX20	TX25

**Art. 9147  
A4**

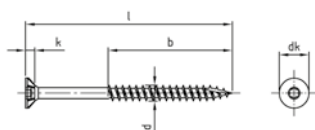

**PRIMJENE**

Idealno za zavijčavanje u drvu. Optimalna geometrija navoja osigurava najbolju čvrstoću u različitim drvenim materijalima. TX prihvat omogućava optimalan prijenos snage.

**APPLICATIONS**

Ideal for screwing in wood. The optimal thread geometry ensures the best grip in a variety of wood materials. By recording TX optimum power transmission is achieved.

**KARAKTERISTIKE**

- Upuštena glava 90°
- pojačanje donje glave
- TX šesterokraki zvjezdasti upust
- vrh za rezanje
- rebra za guljenje ispod glave

**FEATURES**

- countersunk 90°
- double countersunk head
- TX drive
- cutting point
- ribs under the head



**Artikl 9147 A4 TX  
Vijci s upuš. glavom za drvo s rebrima i urezom**

Item 9147 A4 TX

Double CSK head timber screws with ribs, cutting point

d	6	8	10
l/mm	Kat.-broj/Item no.	Kat.-broj/Item no.	Kat.-broj/Item no.
12			
16			
20	9147460 20		
25	9147460 25		
30	9147460 30/20	9147480 30	
35	9147460 35/24		
40	9147460 40/24	9147480 40	
45	9147460 45/30		
50	9147460 50/30	9147480 50	
55	9147460 55/36		
60	9147460 60/36	9147480 60	91474100 60/50
65	9147460 65/36		
70	9147460 70/42	9147480 70/50	91474100 70/55
80	9147460 80/48	9147480 80/50	91474100 80/55
90	9147460 90/54	9147480 90/60	91474100 90/55
100	9147460 100/70	9147480 100/80	91474100 100/55
110	9147460 110/70	9147480 110/80	91474100 110/80
120	9147460 120/70	9147480 120/80	91474100 120/80
130	9147460 130/70	9147480 130/80	91474100 130/80
140	9147460 140/70	9147480 140/80	91474100 140/80
150	9147460 150/70	9147480 150/80	91474100 150/80
160	9147460 160/70	9147480 160/80	91474100 160/80
170	9147460 170/70	9147480 170/80	91474100 170/80
180	9147460 180/70	9147480 180/80	91474100 180/105
190	9147460 190/70	9147480 190/80	91474100 190/105
200	9147460 200/70	9147480 200/80	91474100 200/105
220	9147460 220/70	9147480 220/80	91474100 220/105
240	9147460 240/70	9147480 240/80	91474100 240/105
250		9147480 250/80	
260	9147460 260/70	9147480 260/80	91474100 260/105
280	9147460 280/70	9147480 280/80	91474100 280/105
300	9147460 300/70	9147480 300/80	91474100 300/105
320		9147480 320/80	91474100 320/105
340		9147480 340/80	91474100 340/105
350		9147480 350/80	
360		9147480 360/80	91474100 360/105
380		9147480 380/80	
400		9147480 400/80	91474100 400/105

	100	100	100 ≥340: box = 50
dk	12	15	19
k	3.6	4.1	4.7
Veličina p Drive size	TX25	TX40	TX40

## Artikl 9048 A2 PZ Vijci okrugle pojačane glave za ugradnju u drvo, puni navoj

Art. 9048  
A2

Item 9048 A2 PZ

Double pan head timber screws with fullthread

d	3	3,5	4	4,5	5	5,5
l/mm	Kat.-broj/Item no.	Kat.-broj/Item no.	Kat.-broj/Item no.	Kat.-broj/Item no.	Kat.-broj/Item no.	Kat.-broj/Item no.
10	9048230 10	9048235 10	9048240 10			
12	9048230 12	9048235 12	9048240 12	9048245 12		
16	9048230 16	9048235 16	9048240 16	9048245 16	9048250 16	
20	9048230 20	9048235 20	9048240 20	9048245 20	9048250 20	
25	9048230 25	9048235 25	9048240 25	9048245 25	9048250 25	
30	9048230 30	9048235 30	9048240 30	9048245 30	9048250 30	
35	9048230 35	9048235 35	9048240 35	9048245 35	9048250 35	
40	9048230 40	9048235 40	9048240 40	9048245 40	9048250 40	
45		9048235 45	9048240 45	9048245 45	9048250 45	
50		9048235 50	9048240 50	9048245 50	9048250 50	9048255 50
55			9048240 55	9048245 55	9048250 55	
60			9048240 60	9048245 60	9048250 60	
65			9048240 65	9048245 65	9048250 65	
70			9048240 70	9048245 70	9048250 70	
80				9048245 80	9048250 80	
90					9048250 90	
100					9048250 100	
110						

Više dimenzija na sljedećoj stranici. / Further dimensions on the next page.

	500	500 ≥40: box=200	500 ≥40: box=200	500 ≥40: box=200	500 ≥40: box=200 ≥60: box=100	200
dk	6	7	8	9	10	10,5
k	2,5	2,6	3	3,1	3,7	
Veličina p Drive size	PZ1	PZ2	PZ2	PZ2	PZ2	PZ3

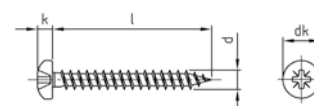

### PRIMJENE

Idealno za zavijčavanje u drvo. Optimalna geometrija navoja osigurava najbolju čvrstoću u različitim drvenim materijalima.

### APPLICATIONS

Ideal for screwing in wood. The optimal thread geometry ensures the best grip in a variety of wood materials.

### KARAKTERISTIKE

- Puni navoj
- okrugla glava
- pojačanje donje glave
- PZ
- standardni vrh

### FEATURES

- fullthread
- raised pan head
- double pan head
- PZ Pozidrive
- standard tip



**Art. 9048  
A2**

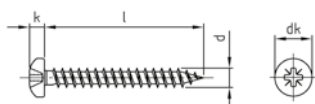

**PRIMJENE**

Idealno za zavijčavanje u drvu. Optimalna geometrija navoja osigurava najbolju čvrstoću u različitim drvenim materijalima.

**APPLICATIONS**

Ideal for screwing in wood. The optimal thread geometry ensures the best grip in a variety of wood materials.

**KARAKTERISTIKE**

- Puni navoj
- okrugla glava
- pojačanje donje glave
- PZ
- standardni vrh

**FEATURES**

- fullthread
- raised pan head
- double pan head
- PZ Pozidrive
- standard tip



**Artikl 9048 A2 PZ  
Vijci okrugle pojačane glave za ugradnju u drvo, puni navoj**

Item 9048 A2 PZ

Double pan head timber screws with fullthread

d 6	
l/mm	Kat.-broj/Item no.
10	
12	
16	
20	9048260 20
25	9048260 25
30	9048260 30
35	9048260 35
40	9048260 40
45	9048260 45
50	9048260 50
55	9048260 55
60	9048260 60
65	9048260 65
70	9048260 70
80	9048260 80
90	9048260 90
100	9048260 100
110	9048260 110

	100
dk	12
k	4.7
<b>Veličina p</b> Drive size	PZ3

## Artikli 9048 A2 PZ Vijci okrugle pojačane glave za ugradnju u drvo, djelomični navoj

Art. 9048  
A2

Item 9048 A2 PZ

Double pan head timber screws with partial thread

d	6
l/mm	Kat.-broj/Item no.
120	9048260 120/70
130	9048260 130/70
140	9048260 140/70
150	9048260 150/70
160	9048260 160/70
180	9048260 180/70
200	9048260 200/70

	100
dk	12
k	4.7

Veličina p  
Drive size

PZ3

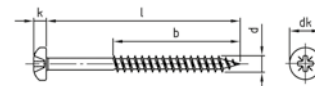

### PRIMJENE

Idealno za zavijčavanje u drvo. Optimalna geometrija navoja osigurava najbolju čvrstoću u različitim drvenim materijalima.

### APPLICATIONS

Ideal for screwing in wood. The optimal thread geometry ensures the best grip in a variety of wood materials.

### KARAKTERISTIKE

- Djelomični navoj
- okrugla glava
- pojačanje donje glave
- PZ Pozidrive
- standardni vrh

### FEATURES

- partial thread
- raised pan head
- double pan head
- PZ Pozidrive
- standard tip



**Art. 9049  
A2**

**Artikli 9049 A2 PZ  
Vijci lećaste upušć glave za stezne ploće, puni navoj**

Item 9049 A2 PZ

Double raised countersunk head timber screws with fullthread

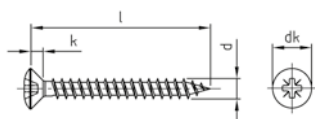

**PRIMJENE**

Idealno za zavijćavanje u drvu. Optimalna geometrija navoja osigurava najbolju ćvrstoću u različitim drvenim materijalima.

**APPLICATIONS**

Ideal for screwing in wood. The optimal thread geometry ensures the best grip in a variety of wood materials.

**KARAKTERISTIKE**

- Puni navoj
- lećasta upušćena glava
- pojaćanje donje glave
- PZ Pozidrive
- standardni vrh

**FEATURES**

- fullthread
- raised countersunk head
- double raised countersunk head
- PZ Pozidrive
- standard tip



d	3	3,5	4	4,5	5	6
l/mm	Kat.-broj/Item no.	Kat.-broj/Item no.	Kat.-broj/Item no.	Kat.-broj/Item no.	Kat.-broj/Item no.	Kat.-broj/Item no.
10	9049230 10	9049235 10	9049240 10			
12	9049230 12	9049235 12	9049240 12	9049245 12		
16	9049230 16	9049235 16	9049240 16	9049245 16	9049250 16	
20	9049230 20	9049235 20	9049240 20	9049245 20	9049250 20	9049260 20
25	9049230 25	9049235 25	9049240 25	9049245 25	9049250 25	9049260 25
30	9049230 30	9049235 30	9049240 30	9049245 30	9049250 30	9049260 30
35	9049230 35	9049235 35	9049240 35	9049245 35	9049250 35	9049260 35
40	9049230 40	9049235 40	9049240 40	9049245 40	9049250 40	9049260 40
45		9049235 45	9049240 45	9049245 45	9049250 45	9049260 45
50		9049235 50	9049240 50	9049245 50	9049250 50	9049260 50
55			9049240 55	9049245 55	9049250 55	9049260 55
60			9049240 60	9049245 60	9049250 60	9049260 60
65			9049240 65	9049245 65	9049250 65	9049260 65
70			9049240 70	9049245 70	9049250 70	9049260 70
75					9049250 75	
80				9049245 80	9049250 80	9049260 80
90					9049250 90	9049260 90
100					9049250 100	9049260 100

	500	500 ≥40: box = 200	500 ≥40: box = 200	500 ≥40: box = 200	500 ≥40: box = 200 ≥60: box = 100	100
dk	6	7	8	9	10	12
k	1.9	2.1	2.5	2.7	3	3.6
Velićina p Drive size	PZ1	PZ2	PZ2	PZ2	PZ2	PZ3

## Artikl 9049 A2 PZ Vijci lećaste upušć pojaćane glave za stezne ploće, djelomićni navoj

Art. 9049  
A2

Item 9049 A2 PZ

Double raised countersunk head timber screws with partial thread

d	6
l/mm	Kat.-broj/Item no.
110	9049260 110/70
120	9049260 120/70
130	9049260 130/70
140	9049260 140/70
150	9049260 150/70
160	9049260 160/70
180	9049260 180/70
200	9049260 200/70

	100
dk	12
k	3.6
Velićina p Drive size	PZ3

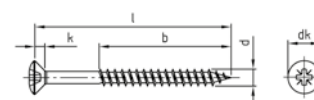

### PRIMJENE

Idealno za zavijćavanje u drvu. Optimalna geometrija navoja osigurava najbolju ćvrstoću u razlićitim drvenim materijalima.

### APPLICATIONS

Ideal for screwing in wood. The optimal thread geometry ensures the best grip in a variety of wood materials.

### KARAKTERISTIKE

- Djelomićni navoj
- lećasta upušćena glava
- pojaćanje donje glave
- PZ Pozidrive
- standardni vrh

### FEATURES

- partial thread
- raised countersunk head
- double raised countersunk head
- PZ Pozidrive
- standard tip



**Art. 9050  
A2**

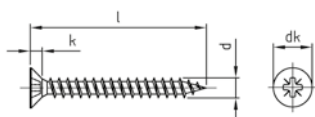

**PRIMJENE**

Idealno za zavijčavanje u drvo. Optimalna geometrija navoja osigurava najbolju čvrstoću u različitim drvenim materijalima.

**APPLICATIONS**

Ideal for screwing in wood. The optimal thread geometry ensures the best grip in a variety of wood materials.

**KARAKTERISTIKE**

- Puni navoj
- upuštena glava 90°
- pojačanje donje glave
- PZ Pozidrive
- standardni vrh

**FEATURES**

- fullthread
- countersunk head 90°
- double countersunk head
- PZ Pozidrive
- standard tip



**Artikli 9050 A2 PZ  
Vijci upuštene pojačane glave za ugradnju u drvo, puni navoj**

Item 9050 A2 PZ

Double countersunk head timber screws with fullthread

d	3	3,5	4	4,5	5	6
l/mm	Kat.-broj/Item no.	Kat.-broj/Item no.	Kat.-broj/Item no.	Kat.-broj/Item no.	Kat.-broj/Item no.	Kat.-broj/Item no.
10	9050230 10	9050235 10	9050240 10			
12	9050230 12	9050235 12	9050240 12	9050245 12		
16	9050230 16	9050235 16	9050240 16	9050245 16	9050250 16	
20	9050230 20	9050235 20	9050240 20	9050245 20	9050250 20	9050260 20
25	9050230 25	9050235 25	9050240 25	9050245 25	9050250 25	9050260 25
30	9050230 30	9050235 30	9050240 30	9050245 30	9050250 30	9050260 30
35	9050230 35	9050235 35	9050240 35	9050245 35	9050250 35	9050260 35
40	9050230 40	9050235 40	9050240 40	9050245 40	9050250 40	9050260 40
45	9050230 45	9050235 45	9050240 45	9050245 45	9050250 45	9050260 45
50	9050230 50	9050235 50	9050240 50	9050245 50	9050250 50	9050260 50
55			9050240 55	9050245 55	9050250 55	9050260 55
60			9050240 60	9050245 60	9050250 60	9050260 60
65			9050240 65	9050245 65	9050250 65	9050260 65
70			9050240 70	9050245 70	9050250 70	9050260 70
80			9050240 80	9050245 80	9050250 80	9050260 80
90				9050245 90	9050250 90	9050260 90
100				9050245 100	9050250 100	9050260 100

	500 ≥40: box=200	500 ≥40: box=200	500 ≥40: box=200	500 ≥40: box=200	500 ≥40: box=200 ≥60: box=100	100
dk	6	7	8	9	10	12
k	1.9	2.1	2.5	2.7	3	3.6
Veličina p Drive size	PZ1	PZ2	PZ2	PZ2	PZ2	PZ3

## Artikl 9050 A2 PZ Vijci upuštene pojačane glave za ugradnju u drvo, djelomični navoj

Art. 9050  
A2

Item 9050 A2 PZ

Double countersunk head timber screws with partial thread

d	3	3,5	4	4,5	5
l/mm	Kat.-broj/Item no.	Kat.-broj/Item no.	Kat.-broj/Item no.	Kat.-broj/Item no.	Kat.-broj/Item no.
25	9050230 25/18	9050235 25/18	9050240 25/18	9050245 25/18	9050250 25/18
30	9050230 30/18	9050235 30/18	9050240 30/18	9050245 30/18	9050250 30/20
35	9050230 35/24	9050235 35/24	9050240 35/24	9050245 35/24	9050250 35/24
40	9050230 40/24	9050235 40/24	9050240 40/24	9050245 40/24	9050250 40/24
45	9050230 45/30	9050235 45/30	9050240 45/30	9050245 45/30	9050250 45/30
50	9050230 50/30	9050235 50/30	9050240 50/30	9050245 50/30	9050250 50/30
55			9050240 55/36	9050245 55/36	9050250 55/36
60			9050240 60/36	9050245 60/36	9050250 60/36
65			9050240 65/36	9050245 65/42	9050250 65/36
70			9050240 70/42	9050245 70/42	9050250 70/42
80			9050240 80/48	9050245 80/48	9050250 80/48
90				9050245 90/54	9050250 90/54
100				9050245 100/60	9050250 100/60
110					9050250 110/70
120					9050250 120/70
130					
140					
150					
160					
170					
180					
190					
200					
220					
240					
260					
280					
300					

Više dimenzija na sljedećoj stranici. / Further dimensions on the next page.

	500 ≥40: box=200	500 ≥40: box=200	500 ≥40: box=200	500 ≥40: box=200	500 ≥40: box=200 ≥60: box=100
dk	6	7	8	9	10
k	1.9	2.1	2.5	2.7	3
Veličina p Drive size	PZ1	PZ2	PZ2	PZ2	PZ2

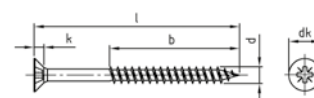

### PRIMJENE

Idealno za zavijčavanje u drvo. Optimalna geometrija navoja osigurava najbolju čvrstoću u različitim drvenim materijalima.

### APPLICATIONS

Ideal for screwing in wood. The optimal thread geometry ensures the best grip in a variety of wood materials.

### KARAKTERISTIKE

- Djelomični navoj
- upuštena glava 90°
- PZ Pozidrive
- standardni vrh
- od promjera 10, 8 i od 6 x 140 mm rebra za glodanje ispod glave

### FEATURES

- partial thread
- countersunk head 90°
- PZ Pozidrive
- standard tip
- at Diameter 10, 8 and at 6 x 140mm ribs under the head



**Art. 9050  
A2**

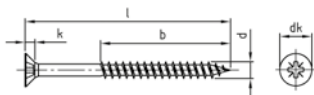

**PRIMJENE**

Idealno za zavijčavanje u drvu. Optimalna geometrija navoja osigurava najbolju čvrstoću u različitim drvenim materijalima.

**APPLICATIONS**

Ideal for screwing in wood. The optimal thread geometry ensures the best grip in a variety of wood materials.

**KARAKTERISTIKE**

- Djelomični navoj
- upuštena glava 90°
- PZ Pozidrive
- standardni vrh
- od promjera 10, 8 i od 6 x 140 mm rebra za glodanje ispod glave

**FEATURES**

- partial thread
- countersunk head 90°
- PZ Pozidrive
- standard tip
- at Diameter 10, 8 and at 6 x 140mm ribs under the head



**Artikl 9050 A2 PZ  
Vijci upuštene pojačane glave za ugradnju u drvo, djelomični navoj**

Item 9050 A2 PZ

Double countersunk head timber screws with partial thread

d	6
l/mm	Kat.-broj/Item no.
25	
30	9050260 30/20
35	9050260 35/24
40	9050260 40/24
45	9050260 45/30
50	9050260 50/30
55	9050260 55/36
60	9050260 60/36
65	9050260 65/42
70	9050260 70/42
80	9050260 80/48
90	9050260 90/54
100	9050260 100/70
110	9050260 110/70
120	9050260 120/70
130	9050260 130/70
140	9050260 140/70
150	9050260 150/70
160	9050260 160/70
170	9050260 170/70
180	9050260 180/70
190	9050260 190/70
200	9050260 200/70
220	9050260 220/70
240	9050260 240/70
260	9050260 260/70
280	9050260 280/70
300	9050260 300/70

	100
dk	12
k	3.6
Veličina p Drive size	PZ3

## Artikl 9050 A4 PZ Vijci upuštene pojačane glave za ugradnju u drvo, puni navoj

Art. 9050  
A4

Item 9050 A4 PZ

Double countersunk head timber screws with fullthread

d	3	3,5	4	4,5	5	6
l/mm	Kat.-broj/Item no.	Kat.-broj/Item no.	Kat.-broj/Item no.	Kat.-broj/Item no.	Kat.-broj/Item no.	Kat.-broj/Item no.
10	9050430 10	9050435 10	9050440 10			
12	9050430 12	9050435 12	9050440 12	9050445 12		
16	9050430 16	9050435 16	9050440 16	9050445 16	9050450 16	
20	9050430 20	9050435 20	9050440 20	9050445 20	9050450 20	9050460 20
25	9050430 25	9050435 25	9050440 25	9050445 25	9050450 25	9050460 25
30	9050430 30	9050435 30	9050440 30	9050445 30	9050450 30	9050460 30
35	9050430 35	9050435 35	9050440 35	9050445 35	9050450 35	9050460 35
40	9050430 40	9050435 40	9050440 40	9050445 40	9050450 40	9050460 40
45	9050430 45	9050435 45	9050440 45	9050445 45	9050450 45	9050460 45
50	9050430 50	9050435 50	9050440 50	9050445 50	9050450 50	9050460 50
55			9050440 55	9050445 55	9050450 55	9050460 55
60			9050440 60	9050445 60	9050450 60	9050460 60
65			9050440 65	9050445 65	9050450 65	9050460 65
70			9050440 70	9050445 70	9050450 70	9050460 70
80			9050440 80	9050445 80	9050450 80	9050460 80
90				9050445 90	9050450 90	9050460 90
100				9050445 100	9050450 100	9050460 100

	500 ≥40: box = 200	500 ≥40: box = 200	500 ≥40: box = 200	500 ≥40: box = 200	500 ≥40: box = 200 ≥60: box = 100	100
dk	6	7	8	9	10	12
k	1.9	2.1	2.5	2.7	3	3.6
Veličina p Drive size	PZ1	PZ2	PZ2	PZ2	PZ2	PZ3

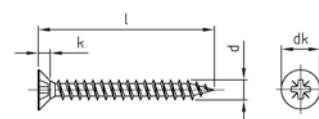

### PRIMJENE

Idealno za zavijčavanje u drvo. Optimalna geometrija navoja osigurava najbolju čvrstoću u različitim drvenim materijalima.

### APPLICATIONS

Ideal for screwing in wood. The optimal thread geometry ensures the best grip in a variety of wood materials.

### KARAKTERISTIKE

- Puni navoj
- upuštena glava 90°
- pojačanje donje glave
- PZ Pozidrive
- standardni vrh

### FEATURES

- fullthread
- countersunk head 90°
- double countersunk head
- PZ Pozidrive
- ribs under the head
- standard tip



## Art. 9050 A4

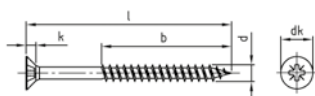

### PRIMJENE

Idealno za zavijčavanje u drvo. Optimalna geometrija navoja osigurava najbolju čvrstoću u različitim drvenim materijalima.

### APPLICATIONS

Ideal for screwing in wood. The optimal thread geometry ensures the best grip in a variety of wood materials.

### KARAKTERISTIKE

- Djelomični navoj
- upuštena glava 90°
- PZ Pozidrive
- standardni vrh
- od promjera 10, 8 i od 6 x 140 mm rebra za glodanje ispod glave

### FEATURES

- partial thread
- countersunk head 90°
- double countersunk head
- PZ Pozidrive
- standard tip
- at Diameter 10, 8 and at 6 x 140mm ribs under the head



## Artikl 9050 A4 PZ Vijci upuštene pojačane glave za ugradnju u drvo, djelomični navoj

Item 9050 A4 PZ

Double countersunk head timber screws with partial thread

d	3	3,5	4	4,5	5
l/mm	Kat.-broj/Item no.	Kat.-broj/Item no.	Kat.-broj/Item no.	Kat.-broj/Item no.	Kat.-broj/Item no.
25	9050430 25/18	9050435 25/18	9050440 25/18	9050445 25/18	9050450 25/18
30	9050430 30/18	9050435 30/18	9050440 30/18	9050445 30/18	9050450 30/20
35	9050430 35/24	9050435 35/24	9050440 35/24	9050445 35/24	9050450 35/24
40	9050430 40/24	9050435 40/24	9050440 40/24	9050445 40/24	9050450 40/24
45	9050430 45/30	9050435 45/30	9050440 45/30	9050445 45/30	9050450 45/30
50	9050430 50/30	9050435 50/30	9050440 50/30	9050445 50/30	9050450 50/30
55			9050440 55/36	9050445 55/36	9050450 55/36
60			9050440 60/36	9050445 60/36	9050450 60/36
65			9050440 65/42	9050445 65/42	9050450 65/36
70			9050440 70/42	9050445 70/42	9050450 70/42
80			9050440 80/48	9050445 80/48	9050450 80/48
90				9050445 90/54	9050450 90/54
100				9050445 100/60	9050450 100/60
110					9050450 110/70
120					9050450 120/70
130					
140					
150					
160					
170					
180					
190					
200					
220					
240					
260					
280					
300					

	500 ≥40: box = 200	500 ≥40: box = 200	500 ≥40: box = 200	500 ≥40: box = 200	500 ≥40: box = 200 ≥60: box = 100
dk	6	7	8	9	10
k	1.9	2.1	2.5	2.7	3
Veličina p Drive size	PZ1	PZ2	PZ2	PZ2	PZ2

**Artikl 9050 A4 PZ**  
**Vijci upuštene pojačane glave za ugradnju u drvo, djelomični navoj**

**Art. 9050**  
**A4**

Item 9050 A4 PZ

Double countersunk head timber screws with partial thread

6

Kat.-broj/Item no.

9050460 30/20  
9050460 35/24  
9050460 40/24  
9050460 45/30  
9050460 50/30  
9050460 55/36  
9050460 60/36  
9050460 65/42  
9050460 70/42  
9050460 80/48  
9050460 90/54  
9050460 100/70  
9050460 110/70  
9050460 120/70  
9050460 130/70  
9050460 140/70  
9050460 150/70  
9050460 160/70  
9050460 170/70  
9050460 180/70  
9050460 190/70  
9050460 200/70  
9050460 220/70  
9050460 240/70  
9050460 260/70  
9050460 280/70  
9050460 300/70

100

12

3.6

PZ3

## Art. 9250 A2

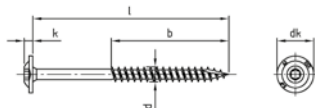

### PRIMJENE

Idealno za zavijčavanje vani, npr. solarnih postrojenja, nadstrešnica, balkona, šetnica, opreme za igranje, montažnih kuća, kao i svih nosivih elemenata. Idealno za zavijčavanje vani, npr. solarnih postrojenja, nadstrešnica, balkona, šetnica, opreme za igranje, montažnih kuća, kao i svih nosivih elemenata. Potrebna je minimalna dubina zavijčavanja od 4 X promjera. U idealnom slučaju trebala bi se moći ostvariti dubina zavijčavanja od 8 X promjera. U obračun se ne smije uključiti dubina veća od 12 X promjera

### APPLICATIONS

Ideal for Outdoor screw connections such as solar equipment, car ports, balconies, steps, playground equipment, prefabricated houses and all supporting components  
A minimum screw-in depth of 4x the diameter must be ensured. A screw-in depth of 8x the diameter should ideally be achieved. More than 12x the diameter must not be included in calculations.

### KARAKTERISTIKE

- Djelomični navoj
- tanjurasta glava - vijak za drvo
- vrh za rezanje
- poseban sloj za lako sklizanje
- pogon s TX šesterokrakim zvjezdastim upustom

### FEATURES

- Pan washer head timber screws
- cutting point
- Anti-Friction-coating
- TX drive



## Artikl 9250 A2 TX Tanjirasti vijci za ugradnju u drvo s urezom, djelomični navoj

Item 9250 A2 TX

Pan washer head timber screws with cutting point

d	3	4	4,5	5	6
l/mm	Kat.-broj/Item no.	Kat.-broj/Item no.	Kat.-broj/Item no.	Kat.-broj/Item no.	Kat.-broj/Item no.
20	9250230 20	9250240 20	9250245 20		
25	9250230 25/18	9250240 25/18	9250245 25/18	9250250 25/18	
30	9250230 30/18	9250240 30/18	9250245 30/18	9250250 30/20	9250260 30/20
35	9250230 35/24	9250240 35/24	9250245 35/24	9250250 35/24	9250260 35/24
40	9250230 40/24	9250240 40/24	9250245 40/24	9250250 40/24	9250260 40/24
45	9250230 45/30	9250240 45/30	9250245 45/30	9250250 45/30	9250260 45/30
50	9250230 50/30	9250240 50/30	9250245 50/30	9250250 50/30	9250260 50/30
55		9250240 55/36	9250245 55/36	9250250 55/36	9250260 55/36
60		9250240 60/36	9250245 60/36	9250250 60/36	9250260 60/36
65		9250240 65/36	9250245 65/36	9250250 65/36	9250260 65/36
70		9250240 70/42	9250245 70/42	9250250 70/42	9250260 70/42
80		9250240 80/48	9250245 80/48	9250250 80/48	9250260 80/48
90			9250245 90/54	9250250 90/54	9250260 90/54
100			9250245 100/60	9250250 100/60	9250260 100/70
110					9250260 110/70
120				9250250 120/70	9250260 120/70
130					9250260 130/70
140					9250260 140/70
150					9250260 150/70
160					9250260 160/70
170					9250260 170/70
180					9250260 180/70
190					9250260 190/70
200					9250260 200/70
220					9250260 220/70
240					9250260 240/70
250					
260					9250260 260/70
280					9250260 280/70
300					9250260 300/70
320					
340					
350					
360					
380					
400					

	200	200	200	200 ≥60: box = 100	100 ≥200: box = 50
dk	9	12	13	14	15
k	2.2	3	3.2	3.5	3.8
Veličina p Drive size	TX10	TX20	TX20	TX25	TX25

**Artikl 9250 A2 TX**  
**Tanjirasti vijci za ugradnju u drvo s urezom, djelomični navoj**

**Art. 9250**  
**A2**

Item 9250 A2 TX

Pan washer head timber screws with cutting point

8	10
Kat.-broj/Item no.	Kat.-broj/Item no.
9250280 30	
9250280 40	
9250280 50	
9250280 60/50	92502100 60/50
9250280 70/50	92502100 70/55
9250280 80/72	92502100 80/55
9250280 90/80	92502100 90/55
9250280 100/80	92502100 100/55
9250280 110/80	92502100 110/80
9250280 120/80	92502100 120/80
9250280 130/80	92502100 130/80
9250280 140/80	92502100 140/80
9250280 150/80	92502100 150/80
9250280 160/80	92502100 160/80
9250280 170/80	92502100 170/80
9250280 180/80	92502100 180/105
9250280 190/80	92502100 190/105
9250280 200/80	92502100 200/105
9250280 220/80	92502100 220/105
9250280 240/80	92502100 240/105
9250280 250/80	92502100 250/105
9250280 260/80	92502100 260/105
9250280 280/80	92502100 280/105
9250280 300/80	92502100 300/105
9250280 320/80	92502100 320/105
9250280 340/80	92502100 340/105
9250280 350/80	92502100 350/105
9250280 360/80	92502100 360/105
9250280 380/80	92502100 380/105
9250280 400/80	92502100 400/105

100 ≥120: box = 50	100 ≥120: box = 50
20	25
4.6	5
TX40	TX40

## Art. 9250 A4

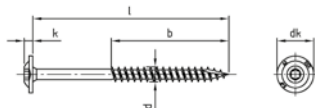

### PRIMJENE

Idealno za zavijčavanje vani, npr. solarnih postrojenja, nadstrešnica, balkona, šetnica, opreme za igranje, montažnih kuća, kao i svih nosivih elemenata. Idealno za zavijčavanje vani, npr. solarnih postrojenja, nadstrešnica, balkona, šetnica, opreme za igranje, montažnih kuća, kao i svih nosivih elemenata. Potrebna je minimalna dubina zavijčavanja od 4 X promjera. U idealnom slučaju trebala bi se moći ostvariti dubina zavijčavanja od 8 X promjera. U obračun se ne smije uključiti dubina veća od 12 X promjera

### APPLICATIONS

Ideal for Outdoor screw connections such as solar equipment, car ports, balconies, steps, playground equipment, prefabricated houses and all supporting components  
A minimum screw-in depth of 4x the diameter must be ensured. A screw-in depth of 8x the diameter should ideally be achieved. More than 12x the diameter must not be included in calculations.

### KARAKTERISTIKE

- Djelomični navoj
- tanjurasta glava - vijak za drvo
- vrh za rezanje
- poseban sloj za lako sklizanje
- pogon s TX šesterokrakim zvjezdastim upustom

### FEATURES

- Pan washer head timber screws
- cutting point
- Anti-Friction-coating
- TX drive



## Artikel 9250 A4 TX Tanjirasti vijci za ugradnju u drvo s urezom, djelomični navoj

Item 9250 A4 TX

Pan washer head timber screws with cutting point

d	3	4	4,5	5	6
l/mm	Kat.-broj/Item no.	Kat.-broj/Item no.	Kat.-broj/Item no.	Kat.-broj/Item no.	Kat.-broj/Item no.
20	9250430 20	9250440 20	9250445 20		
25	9250430 25/18	9250440 25/18	9250445 25/18	9250450 25/18	
30	9250430 30/18	9250440 30/18	9250445 30/18	9250450 30/20	9250460 30/20
35	9250430 35/24	9250440 35/24	9250445 35/24	9250450 35/24	9250460 35/24
40	9250430 40/24	9250440 40/24	9250445 40/24	9250450 40/24	9250460 40/24
45	9250430 45/30	9250440 45/30	9250445 45/30	9250450 45/30	9250460 45/30
50	9250430 50/30	9250440 50/30	9250445 50/30	9250450 50/30	9250460 50/30
55		9250440 55/36	9250445 55/36	9250450 55/36	9250460 55/36
60		9250440 60/36	9250445 60/36	9250450 60/36	9250460 60/36
65		9250440 65/36	9250445 65/36	9250450 65/36	9250460 65/36
70		9250440 70/42	9250445 70/42	9250450 70/42	9250460 70/42
80		9250440 80/48	9250445 80/48	9250450 80/48	9250460 80/48
90			9250445 90/54	9250450 90/54	9250460 90/54
100			9250445 100/60	9250450 100/60	9250460 100/70
110					9250460 110/70
120				9250450 120/70	9250460 120/70
130					9250460 130/70
140					9250460 140/70
150					9250460 150/70
160					9250460 160/70
170					9250460 170/70
180					9250460 180/70
190					9250460 190/70
200					9250460 200/70
220					9250460 220/70
240					9250460 240/70
250					
260					9250460 260/70
280					9250460 280/70
300					9250460 300/70
320					
340					
350					
360					
380					
400					

	200	200	200	200 ≥60: box = 100	100 ≥200: box = 50
dk	9	12	13	14	15
k	2.2	3	3.2	3.5	3.8
Veličina p Drive size	TX10	TX20	TX20	TX25	TX25

**Artikel 9250 A4 TX**  
**Tanjirasti vijci za ugradnju u drvo s urezom, djelomični navoj**

**Art. 9250**  
**A4**

Item 9250 A4 TX

Pan washer head timber screws with cutting point

8	10
Kat.-broj/Item no.	Kat.-broj/Item no.
9250480 30	
9250480 40	
9250480 50	
9250480 60/50	92504100 60/50
9250480 70/50	92504100 70/55
9250480 80/72	92504100 80/55
9250480 90/80	92504100 90/55
9250480 100/80	92504100 100/55
9250480 110/80	92504100 110/80
9250480 120/80	92504100 120/80
9250480 130/80	92504100 130/80
9250480 140/80	92504100 140/80
9250480 150/80	92504100 150/80
9250480 160/80	92504100 160/80
9250480 170/80	92504100 170/80
9250480 180/80	92504100 180/105
9250480 190/80	92504100 190/105
9250480 200/80	92504100 200/105
9250480 220/80	92504100 220/105
9250480 240/80	92504100 240/105
9250480 250/80	92504100 250/105
9250480 260/80	92504100 260/105
9250480 280/80	92504100 280/105
9250480 300/80	92504100 300/105
9250480 320/80	92504100 320/105
9250480 340/80	92504100 340/105
9250480 350/80	92504100 350/105
9250480 360/80	92504100 360/105
9250480 380/80	92504100 380/105
9250480 400/80	92504100 400/105

100 ≥120: box = 50	100 ≥120: box = 50
20	25
4.6	5
TX40	TX40

**Art. 9063  
A4**

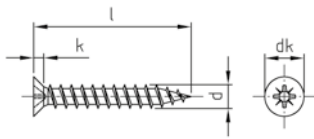

**PRIMJENE**  
Idealno za zavijčavanje drva.

**APPLICATIONS**  
Ideal for screw connections in the wood area.

**Artikl 9063 A4**  
**Vijci za traku šarnira promjera glave 5 mm**

*Item 9063 A4*  
*Hinge tape chipboardscrews with head diameter 5 mm*

d	l	k	dk	Veličina p Drive size	Kataloški broj Item Number	
3	12	1,73	5	PZ1	9063430 12	200
	16	1,73	5	PZ1	9063430 16	200
	20	1,73	5	PZ1	9063430 20	200

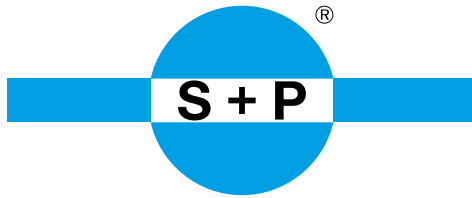

Competence in  
Stainless Steel

# VIJCI ZA DRVENU KONSTRUKCIJU S+P

WOOD SCREWS AT S+P

Broj stavke <i>Item Number</i>	Oznaka II <i>Title II</i>	materijal <i>material</i>			Oblik glave <i>Head shape</i>									
		A2	A4	mart. nehrđajući čelik <i>martensitic stainless steel</i>	Seko 90°	Seko 90°	Seko 80°	Seko 80°	Ziko 90°	Ziko 90°	Ziko 60°	Ziko 60°	pločasta glava <i>Flat head</i>	Okrugle glave <i>Cross recessed pan head</i>
9040	Super-Drill vijci za drvo s vrhom za bušenje <i>Super-Drill CSK head timber screws with drilling point</i>	x			x									
9041	Podni vijci sa šestokrakim zvjezdastim upustom <i>Floorboard screws with six lobe drive</i>	x									x			
9042	Quadra-Speed vijci s upušt glav s vrhom za rezanje <i>Quadra Speed, CSK head screws, cutting point</i>		x		x									
9043	T-Drill vijci za mont. na terasi s vrh. za rezanje <i>T-Drill, RSD CSK head terrace screws, cutting point</i>	x	x	x					x					
9044	SP-Drill vijci za stezne ploče s vrhom za rezanje <i>SP-Drill, CSK head timber screws with drilling point</i>	x			x									
9142	SK-Drill vijci za terasu s upušt. glavom i urezom <i>SK-DRILL, CSK head terrace screws, cutting point</i>	x	x					x						
9143	TBS-Drill vijci za terasu s upušt. glavom i urezom <i>TBS-Drill CSK head terrace screws, cutting point</i>	x						x						
9241	vijci za drvo s ukras. glavom, vrh za buš. i rebra <i>RSD csk head timber screws, drilling point, milling ribs</i>			x							x			
9242	Vijci za drvo s ukras. glavom s urezom u navoju i rebrima za guljenje <i>RSD csk head timber screws, cutting point, milling ribs</i>	x	x	x							x			
9243	TBS-Drill Vijci za terase cilindar glava <i>TBS-Drill, cyl. head terrace screws</i>		x	x										
9244	Vijci s upušt. glavom za drvo, s vrhom za bušenje <i>CSK head timber screws with drilling point</i>			x	x									
9245	TBS-Drill Vijci za terase, cilindar glava, usjed <i>TBS-Drill, cyl. head terrace screws, cutting point</i>			x										
9246	Vijci s upušt. glavom za drvo, vrh za buš. i rebra <i>CSK head timber screws, drilling point, milling ribs</i>			x	x									
9045	Vijci okrugle pojačane glave za ugradnju u drvo, puni navoj <i>Double pan head timber screws with fullthread</i>	x	x										x	
9046	Vijci lečaste upušt pojačane glave za stezne ploče, puni navoj <i>Double raised countersunk head timber screws with fullthread</i>	x	x											
9047	Vijci upuštene pojačane glave za ugradnju u drvo, puni navoj <i>Double countersunk head timber screws with fullthread</i>	x	x		x									
9147	Vijci s upušt. glavom za drvo s rebrima i urezom <i>Double CSK head timber screws with ribs, cutting point</i>	x	x	x	x									
9048	Vijci okrugle pojačane glave za ugradnju u drvo, puni navoj <i>Double pan head timber screws with fullthread</i>	x											x	
9049	Vijci lečaste upušt pojačane glave za stezne ploče, puni navoj <i>Double raised countersunk head timber screws with fullthread</i>	x												
9050	Vijci upuštene pojačane glave za ugradnju u drvo, puni navoj <i>Double countersunk head timber screws with fullthread</i>	x	x		x									
9250	Tanjirasti vijci za ugradnju u drvo s urezom, djelomični navoj <i>Pan washer head timber screws with cutting point</i>	x	x									x		
9063	Vijci za traku šarnira promjera glave 5 mm <i>Hinge tape chipboardscrews with head diameter 5 mm</i>	x	x		x									

Križno upuštena upuštena glava <i>Cross recessed countersunk head</i>	glava cilindra <i>Cylinder head</i>	glodanje rebara <i>ribs under the head</i>	Snimanje <i>Drive</i>		Sjajno <i>tip</i>			Navoj / osovina <i>Thread / Shank</i>			Razno <i>Others</i>		napomena <i>remark</i>
			TX snimanje <i>TX Drive</i>	PZ snimanje <i>PZ Drive</i>	svrdlo <i>Drilling point</i>	rezanje zarez <i>Cutting point</i>	Standardni savjet <i>Standard tip</i>	Djelomična nit <i>Partial thread</i>	S punim navojem <i>Fullthread</i>	Podglavni navoj <i>thread under the head</i>	guljenje rebara <i>milling ribs</i>	Dozvola / Označavanje <i>Approval / identification</i>	
		x	x		x			x				ETA 11/0283	
		x	x		x			x				CE 14592	
		x	x			x		x				CE 14592	
		x	x			x		x			x	ETA 11/0283	A2 + A4 = CE 14592
		x	x		x			x				ETA 11/0283	
		x	x			x		x				CE 14592	
		x	x			x		x		x		CE 14592	
		x	x		x			x			x	ETA 11/0283	
		x	x			x		x			x	ETA 11/0283	također kao brunirano u A2 + A4 <i>also burnished finished in A2 + A4</i>
	x		x				x	x		x		ETA 11/0283	
		x	x		x			x				ETA 11/0283	
	x		x			x		x			x	ETA 11/0283	
		x	x		x			x			x	ETA 11/0283	
			x				x	x	x			ETA 11/0283	
x			x				x	x	x			ETA 11/0283	
			x				x	x	x			ETA 11/0283	od ø 10,8 i 6 x 140mm rebra za glodanje ispod glave <i>at Diameter ø 10,8 and 6 X 140mm ribs under the head</i>
		x	x			x		x	x			ETA 11/0283	
				x			x	x	x			ETA 11/0283	
x				x			x	x	x			ETA 11/0283	
			x				x	x	x			ETA 11/0283	od ø 10,8 i 6 x 140mm rebra za glodanje ispod glave <i>at Diameter ø 10,8 and 6 X 140mm ribs under the head</i>
			x			x		x	x			ETA 11/0283	
				x			x		x			ETA 11/0283	

# Allgemeine Verkaufs- und Lieferbedingungen der Schäfer + Peters GmbH (künftig auch als „S + P“ bezeichnet) Stand 10/2022

## I. Geltungsbereich

1. Die nachstehenden Verkaufsbedingungen gelten für alle zwischen dem Käufer und S + P geschlossenen Verträge über die Lieferung von Waren und damit in Verbindung stehenden Leistungen (wie z.B. Beratungsleistungen oder Auskünfte), soweit es sich bei dem Käufer um ein Unternehmen, eine juristische Person des öffentlichen Rechts oder ein öffentlich-rechtliches Sondervermögen handelt. Aufträge werden ausschließlich auf der Grundlage nachfolgender Bedingungen ausgeführt. Das Angebot, die Angebotsannahme, die Auftragsbestätigung sowie der Verkauf jeglicher Produkte unterliegen den vorliegenden Bedingungen. Entgegenstehende oder abweichende Bedingungen des Käufers erkennen wir nicht an, es sei denn, wir hätten ausdrücklich ihrer Geltung zugestimmt. Dieses Zustimmungserfordernis gilt in jedem Fall, insbesondere auch dann, wenn wir in Kenntnis entgegenstehender oder abweichender Bedingungen des Käufers die Bestellung des Käufers vorbehaltlos ausführen.
2. In den Verträgen sind alle Vereinbarungen, die zwischen dem Käufer und S + P zur Ausführung der Kaufverträge bis zum Zeitpunkt des jeweiligen Vertragsschlusses getroffen wurden, in Textform niedergelegt. Die Wirksamkeit nachträglich im Einzelfall getroffener Individualvereinbarungen bleibt unberührt.
3. Soweit S + P und der Käufer eine Rahmenvereinbarung getroffen haben, gelten diese Allgemeinen Verkaufsbedingungen sowohl für diese Rahmenvereinbarung als auch für den einzelnen Lieferungs- bzw. Kaufauftrag.
4. Die Allgemeinen Verkaufsbedingungen gelten auch für alle künftigen Geschäftsbeziehungen, auch wenn sie nicht noch einmal ausdrücklich vereinbart werden.

## II. Angebot und Vertragsschluss

1. Eine Bestellung des Käufers, welche als rechtsverbindliches Angebot zum Abschluss eines Kaufvertrages zu qualifizieren ist, können wir innerhalb von zwei Wochen nach unserer Wahl durch Übersendung einer Auftragsbestätigung oder durch vorbehaltlose Erbringung der bestellten Lieferungen oder Leistungen annehmen.
2. Unsere Angebote sind freibleibend und unverbindlich, es sei denn, dass wir diese ausdrücklich als verbindlich bezeichnet haben. Angaben über unsere Waren (insbesondere technische Daten, Maße, Leistungs- und Verbrauchsdaten sowie die Beschreibungen in den jeweiligen Produktinformationen oder Werbematerialien u.a.) sind nur ungefähr und annähernd maßgeblich, soweit nicht die Verwendbarkeit zum vertraglich vorgesehenen Zweck eine genaue Übereinstimmung voraussetzt; sie sind keine garantierte Beschaffenheit, es sei denn, die Garantie erfolgt ausdrücklich und in Textform.
3. An allen Abbildungen, Kalkulationen, Zeichnungen sowie anderen Unterlagen behalten wir uns unsere Eigentums-, Urheber- sowie sonstige Schutzrechte vor. Der Käufer darf diese Gegenstände, unabhängig davon, ob wir sie als vertraulich gekennzeichnet haben, nur mit unserer Einwilligung in Textform als solche oder inhaltlich an Dritte weitergeben, sie bekannt geben, selbst oder durch Dritte nutzen oder vervielfältigen.
4. Angaben zu aktuellen Lagerbeständen sind stets unverbindlich. Werden Bestände dem Kunden mitgeteilt, so handelt es sich hierbei um speziell für Kunden- oder Absatzgruppen vorgehaltene Bestände, die nicht mit dem tatsächlichen Bestand identisch sein müssen.

## III. Zahlungsbedingungen

1. Unsere Preise gelten für den in den Auftragsbestätigungen aufgeführten Leistungs- und Lieferungsumfang. Mehr- oder Sonderleistungen werden gesondert berechnet. Die Preise gelten ab Werk Öhringen zuzüglich Verpackung, Zoll, Versicherung und im Einzelfall zusätzlich anfallender Abgaben, wenn nichts anderes festgelegt wurde. In unseren Preisen ist die gesetzliche Mehrwertsteuer nicht eingeschlossen. Diese werden wir in der gesetzlichen Höhe am Tage der Rechnungsstellung in der Rechnung gesondert ausweisen.
2. Soweit nicht abweichend vereinbart, sind Rechnungen innerhalb von 30 Tagen ab Rechnungsdatum und Lieferung ohne Abzug zur Zahlung fällig. Bei Zahlungen innerhalb von 10 Tagen ab Rechnungsdatum, gewähren wir Skonto von 2%, es sei denn der Käufer befindet sich mit weiteren Zahlungsverpflichtungen uns gegenüber im Zahlungsverzug. Eine Zahlung gilt erst dann als erfolgt, wenn wir über den Betrag verfügen können. Im Falle von Scheckzahlungen gilt die Zahlung erst als erfolgt, wenn der Scheck eingelöst wird.
3. Zahlt der Käufer nicht innerhalb der vorgenannten Frist, so gerät er in Zahlungsverzug, ohne dass es einer erneuten Zahlungsaufforderung bedarf. Im Falle des Zahlungsverzugs ist der Kaufpreis zu dem für Unternehmer gesetzlich geltenden Verzugszinssatz zu verzinsen. Weitergehende Ansprüche bleiben vorbehalten. Leistet der Käufer auch auf eine nochmalige Zahlungsaufforderung nicht, so sind wir dazu berechtigt, alle gegenüber dem Käufer bestehenden Verbindlichkeiten, insbesondere auch gestundete oder in Raten zu zahlende Beträge, sofort fällig zu stellen und etwaige weitere Lieferungen zu versagen.
4. Der Käufer ist zur Aufrechnung und/oder Zurückbehaltung nur berechtigt, wenn die Gegenforderungen rechtskräftig festgestellt sind, von uns anerkannt wurden, unstrittig sind oder wenn die Gegenforderungen aus demselben konkreten Vertragsverhältnis wie die Hauptforderung herrühren und zu dieser in einem Gegenseitigkeitsverhältnis stehen.

5. Soweit S + P dem Käufer Ratenzahlung gewährt hat, wird der noch bestehende Restbetrag dann insgesamt zur Zahlung fällig, wenn der Käufer mit der Zahlung einer Rate länger als 8 Tage in Verzug gerät.
6. Preisänderungen sind zulässig, wenn zwischen Vertragsabschluss und vereinbartem Liefertermin mehr als vier Monate vergangen sind und die Preisänderung auf eine aktuelle Kostensteigerung zurückzuführen ist, welche wir nicht zu vertreten haben. Eine Kostensteigerung liegt vor, wenn sich bis zur Lieferung die Löhne, die Materialkosten, die Transportkosten, Transportnebenkosten oder die Vertriebskosten erhöhen. Dasselbe gilt, wenn sich Zölle erhöhen bzw. ein Zoll eingeführt wird oder sich Kostenänderungen aufgrund von Preiserhöhungen von Vorlieferanten oder wegen Wechselkurschwankungen ergeben. S + P ist in diesen Fällen berechtigt, den Preis angemessen entsprechend den Kostensteigerungen zu erhöhen.

## IV. Liefer- und Leistungszeit, Höhere Gewalt, Haftung bei Lieferverzug

1. Liefertermine oder Fristen, die nicht ausdrücklich als verbindlich vereinbart oder ausdrücklich verbindlich von uns zugesagt worden sind, sind ausschließlich unverbindliche Angaben. Sie gelten nur annäherungsweise und beschreiben den voraussichtlichen Liefertermin. Hiervon abweichende Vereinbarungen oder Zusagen über eine verbindliche Lieferzeit müssen ausdrücklich und in Textform erfolgen. Die Lieferzeit beginnt erst dann zu laufen, wenn der Käufer die seinerseits geschuldeten Mitwirkungshandlungen ordnungsgemäß und vollständig erbracht hat.
2. Erhalten wir aus von uns nicht zu vertretenden Gründen Lieferungen oder Leistungen unserer Unterlieferanten oder von Subunternehmern trotz ordnungsgemäßer Eindeckung nicht, nicht richtig oder nicht rechtzeitig oder treten Ereignisse höherer Gewalt ein, so werden wir unseren Kunden rechtzeitig in Textform informieren und uns nach besten Kräften bemühen, die Liefer- oder Leistungsstörung oder die höhere Gewalt zu beheben und in ihren Auswirkungen soweit wie möglich zu beschränken. In diesem Fall sind wir berechtigt, die Lieferung bzw. Leistung um die Dauer einer nur vorübergehenden Behinderung herauszuschieben oder im Falle einer wesentlichen Behinderung von nicht nur vorübergehender Dauer wegen des noch nicht erfüllten Teils vom Vertrag ganz oder teilweise zurückzutreten, soweit wir unserer vorstehenden Informationspflicht nachgekommen sind und nicht das Beschaffungsrisiko bzw. Herstellungsrisiko übernommen haben. Der höheren Gewalt stehen gleich sonstige bei Vertragsabschluss nicht vorhersehbare Ereignisse wie rechtmäßige Streiks oder Aussperrungen, behördliche Eingriffe, Energie- und Rohstoffknappheit, unverschuldete Transportengpässe, unverschuldete Betriebsbehinderungen zum Beispiel durch Feuer, Wasser und Maschinenschäden, unerwartet auftretende Pandemien oder Epidemien, kriegs- und kriegsähnliche Handlungen, Wirtschaftssanktionen und alle sonstigen Behinderungen, die bei objektiver Betrachtungsweise nicht von uns schuldhaft herbeigeführt worden sind. Verzögert sich die Lieferung oder Leistung in Folge eines der vorstehend in Satz 1 und 3 genannten Fälle um mehr als einen Monat, so sind sowohl wir als auch der Kunde - unbeschadet des Fristsetzungserfordernisses für den Kunden und unter Ausschluss jeglicher Schadensersatzansprüche - berechtigt, hinsichtlich der von den Lieferstörungen betroffenen Menge vom Vertrag zurückzutreten. Zum Rücktritt vom gesamten Vertrag ist der Kunde berechtigt, wenn ihm die Annahme einer Teillieferung unzumutbar ist.
3. In jedem Falle geraten wir erst nach Ablauf einer vom Kunden gesetzten angemessenen Nachfrist in Lieferverzug, es sei denn, es handelt sich um ein Fixgeschäft im Sinne von § 286 Abs. 2 Nr. 4 BGB oder von § 376 HGB.
4. Unsere gesetzlichen Rechte, insbesondere bei einem Ausschluss der Leistungspflicht (z. B. aufgrund Unmöglichkeit oder Unzumutbarkeit der Leistung und/oder Nacherfüllung), bleiben unberührt. Schadensersatzansprüche aus Lieferverzug sind ausgeschlossen, soweit sie nicht auf einem vorsätzlichen, arglistigen oder grob fahrlässigen Handeln unsererseits oder unserer Erfüllungsgehilfen oder auf der schuldhaften Verletzung wesentlicher Vertragspflichten beruhen. Wesentlich sind diejenigen Vertragspflichten, die vertragswesentliche Rechtspositionen des Kunden schützen, die ihm der Vertrag nach seinem Inhalt und Zweck gerade zu gewähren hat; wesentlich sind ferner solche Vertragspflichten, deren Erfüllung die ordnungsgemäße Durchführung des Vertrages überhaupt erst ermöglicht und auf deren Einhaltung der Vertragspartner regelmäßig vertraut und auch vertrauen darf. Der Haftungsausschluss gilt nicht für Schäden, welche aus der Verletzung des Lebens, des Körpers oder der Gesundheit herrühren oder Garantien betreffen. Im Falle einer einfach fahrlässigen Verletzung einer wesentlichen Vertragspflicht haften wir allerdings nur für den nach Art des Vertragsschlusses vorhersehbaren, vertragstypischen, unmittelbaren Durchschnittsschaden.
5. Wir sind zu Teillieferungen und Teilleistungen nur berechtigt, wenn - die Teillieferung oder Teilleistung für den Kunden im Rahmen des vertraglichen Bestimmungszwecks verwendbar ist, - die Lieferung der restlichen bestellten Waren bzw. die Erbringung der restlichen beauftragten Leistungen sichergestellt ist und - dem Kunden hierdurch kein erheblicher Mehraufwand oder zusätzliche Kosten entstehen (es sei denn, wir erklären uns zur Übernahme dieser Kosten bereit).
6. Kommt der Käufer in Annahmeverzug, so sind wir berechtigt, Ersatz des entstehenden Schadens und etwaiger Mehraufwendungen zu verlangen. Gleiches gilt, wenn der Käufer Mitwirkungspflichten schuldhaft verletzt.

## V. Erfüllungsort, Gefahrübergang, Versand, Verpackung

1. Die Lieferung erfolgt ab Lager in Öhringen, wo auch der Erfüllungsort für die Lieferung ist. Dies gilt auch für den Fall der Nacherfüllung. Auf Verlangen und Kosten des Käufers wird die Ware an einen anderen Bestimmungsort versandt (Versendungskauf).
2. Die Gefahr des zufälligen Untergangs und der zufälligen Verschlechterung der Ware geht spätestens mit der Übergabe auf den Käufer über. Beim Versendungskauf geht jedoch die Gefahr des zufälligen Untergangs und der zufälligen Verschlechterung der Ware sowie die Verzögerungsgefahr bereits mit Auslieferung der Ware an den Spediteur, den Frachtführer oder der sonst zur Ausführung der Versendung bestimmten Person oder Anstalt über. Der Übergabe steht es gleich, wenn der Käufer im Verzug der Annahme ist.
3. Wir werden uns bemühen, hinsichtlich Versandart und Versandweg Wünsche und Interessen des Käufers zu berücksichtigen; dadurch bedingte Mehrkosten - auch bei vereinbarter Frachtfreilieferung - gehen zu Lasten des Käufers.
4. Wir nehmen Transport- und alle sonstigen Verpackungen nach Maßgabe der Verpackungsverordnung nicht zurück; ausgenommen sind Paletten. Der Käufer hat für die Entsorgung der Verpackung, welche in sein Eigentum übergeht, auf eigene Kosten zu sorgen.
5. Wird der Versand auf Wunsch oder wegen Verschuldens des Käufers verzögert, so lagern wir die Waren auf Kosten und Gefahr des Käufers. In diesem Fall steht die Anzeige der Versandbereitschaft dem Versand gleich.
6. Auf Wunsch und Kosten des Käufers werden wir die Lieferung durch eine Transportversicherung absichern. Hierzu bedarf es einer ausdrücklichen Weisung des Käufers in Textform.

## VI. Gewährleistung / Haftungsbegrenzung / Ersatz vergeblicher Aufwendungen

1. Mängelansprüche des Käufers bestehen nur, wenn der Käufer seinen gesetzlich geschuldeten Untersuchungs- und Rügepflichten, insbesondere gemäß § 377 HGB, ordnungsgemäß nachgekommen ist. Unbeschadet der gesetzlichen Anforderungen an eine ordnungsgemäße Untersuchung hat der Käufer die gelieferte Ware nach Ablieferung bei ihm oder dem von ihm bestimmten Dritten sorgfältig und in zumutbarem Umfang - gegebenenfalls stichprobeweise - mindestens auf Maßhaltigkeit, Material, Gewicht und Oberflächenbeschaffenheit zu untersuchen. Dabei erkennbar werdende Mängel sind uns innerhalb einer Woche nach Eingang der Ware in Textform anzuzeigen. Geschieht dies nicht, gilt die Ware als genehmigt. Versteckte Mängel sind S + P unverzüglich in Textform nach ihrer Entdeckung mitzuteilen. Eine ordnungsgemäße Mängelrüge hat die Bereitschaft des Käufers erkennen zu lassen, den beanstandeten Liefergegenstand auf Verlangen von S + P frachtfrei zurückzusenden. Bei berechtigter Mängelrüge vergütet S + P die Kosten des günstigsten Versandweges; dies gilt nicht, soweit die Kosten sich erhöhen, weil der Liefergegenstand sich an einem anderen Ort als dem Ort des bestimmungsgemäßen Gebrauchs befindet. Versäumt der Käufer die ordnungsgemäße Untersuchung und/oder Mängelanzeige, ist unsere Haftung für den nicht bzw. nicht rechtzeitig oder nicht ordnungsgemäß angezeigten Mangel nach den gesetzlichen Vorschriften ausgeschlossen. Bei einer zum Einbau, zur Anbringung oder Installation bestimmten Ware gilt dies auch dann, wenn der Mangel infolge der Verletzung einer dieser Pflichten erst nach der entsprechenden Verarbeitung offenkundig wurde; in diesem Fall bestehen insbesondere keine Ansprüche des Käufers auf Ersatz entsprechender Kosten (Aus- und Einbaukosten).
2. Für die Rechte des Käufers bei Sach- und Rechtsmängeln (einschließlich Falsch- und Minderlieferung sowie unsachgemäßer Montage oder mangelhafter Montageanleitung) gelten die gesetzlichen Vorschriften, soweit nicht vorstehend oder nachfolgend ein anderes bestimmt ist.
3. Grundlage unserer Mängelhaftung ist vor allem die über die Beschaffenheit und die vorausgesetzte Verwendung der Ware (einschließlich Zubehör und Anleitungen) getroffene Vereinbarung. Als Beschaffenheitsvereinbarung in diesem Sinne gelten alle Produktbeschreibungen und Herstellerangaben, die Gegenstand des einzelnen Vertrages sind oder von uns (insbesondere in Katalogen oder auf unserer Internet-Homepage) zum Zeitpunkt des Vertragsschlusses öffentlich bekannt gemacht waren. Soweit die Beschaffenheit nicht vereinbart wurde, ist nach der gesetzlichen Regelung zu beurteilen, ob ein Mangel vorliegt oder nicht (§ 434 Abs. 3 BGB). Öffentliche Äußerungen des Herstellers oder in seinem Auftrag insbesondere in der Werbung oder auf dem Etikett der Ware gehen dabei Äußerungen sonstiger Dritter vor.
4. Unabhängig von den vorstehenden und nachstehenden Regelungen gelten die gesetzlichen Vorschriften in jedem Fall
  - bei vorsätzlichem Handeln unsererseits oder arglistigem Verschweigen eines Mangels;
  - bei Schäden aus der Verletzung des Lebens, des Körpers oder der Gesundheit;
  - bei Ansprüchen nach dem Produkthaftungsgesetz;
  - soweit von uns übernommene Garantien den abweichenden Regelungen entgegenstehen.

In allen Fällen unberührt bleiben die gesetzlichen Sondervorschriften zum Aufwendungsersatz bei Endlieferung der neu hergestellten Ware an einen Verbraucher (Lieferantenregress gem. §§ 478, 445a, 445b bzw. §§ 445c, 327 Abs. 5, 327u BGB), sofern nicht, z.B. im Rahmen einer Qualitätssicherungsverein-

barung, ein gleichwertiger Ausgleich vereinbart wurde.

5. Im Übrigen gelten für die Rechte des Käufers bei Sach- und Rechtsmängeln folgende Besonderheiten:

- a) Haftung auf Schadensersatz und Ersatz vergeblicher Aufwendungen  
Schadensersatzansprüche wegen Rechts- und Sachmängeln sind ausgeschlossen, soweit sie nicht
  - auf einem grob fahrlässigen Handeln unsererseits oder unserer Erfüllungshelfer oder
  - auf der schuldhaften Verletzung wesentlicher Vertragspflichten beruhen. Wesentlich sind diejenigen Vertragspflichten, die vertragswesentliche Rechtspositionen des Kunden schützen, die ihm der Vertrag nach seinem Inhalt und Zweck gerade zu gewähren hat; wesentlich sind ferner solche Vertragspflichten, deren Erfüllung die ordnungsgemäße Durchführung des Vertrages überhaupt erst ermöglicht und auf deren Einhaltung der Vertragspartner regelmäßig vertraut und auch vertrauen darf.

Im Falle einer einfach fahrlässigen Verletzung einer wesentlichen Vertragspflicht haften wir nur für den nach Art des Vertragsschlusses vorhersehbaren, typischerweise eintretenden Schaden.

Ansprüche auf Ersatz vergeblicher Aufwendungen nach § 284 BGB sind dann und insoweit abbedungen, als nach dem zuvor Gesagten ein Anspruch auf Ersatz des Schadens statt der Leistung in wirksamer Weise freigezeichnet worden ist.

### b) Nacherfüllung

- Ist die gelieferte Sache mangelhaft, können wir zunächst wählen, ob wir Nacherfüllung durch Beseitigung des Mangels (Nachbesserung) oder durch Lieferung einer mangelfreien Sache (Ersatzlieferung) leisten. Ist die von uns gewählte Art der Nacherfüllung im Einzelfall für den Käufer unzumutbar, kann er sie ablehnen. Unser Recht, die Nacherfüllung unter den gesetzlichen Voraussetzungen zu verweigern, bleibt unberührt.

- Wurde die von S + P gelieferte Ware beim Käufer selbst bereits in eine andere Sache eingebaut oder an eine andere Sache angebracht, hat uns der Käufer, soweit dies für ihn zumutbar ist, zum Zwecke der Nacherfüllung Gelegenheit zu geben, die Ware selbst zu entfernen und die nachgebesserte oder nachgelieferte Ware selbst erneut einzubauen bzw. anzubringen und uns hierzu eine angemessene Frist zu bestimmen. Dies gilt unabhängig davon, ob wir ursprünglich zusätzlich zur Lieferung auch zum Einbau der Ware oder zu deren Montage verpflichtet waren; durch dieses Vorgehen wird der Einbau oder die Montage der gelieferten Ware auch nicht zum Teil der Nacherfüllung.

- Hat der Käufer die durch S + P gelieferte Ware bereits weiterverkauft, hat der Käufer gegenüber S + P auch dann eine vorherige und angemessene Frist zur Nacherfüllung zu setzen, wenn der Käufer die Ware von seinem Abnehmer in Folge der Mangelhaftigkeit zurücknehmen musste oder der Abnehmer des Käufers den Kaufpreis gemindert hat.

- Unser Recht, die Nacherfüllung unter den gesetzlichen Voraussetzungen zu verweigern, bleibt unberührt.

### c) Ersatz von Aufwendungen zur Nacherfüllung

- Der Käufer ist erst berechtigt, bei ihm selbst zum Zwecke der Nacherfüllung erforderlich werdende Aufwendungen, insbesondere zum Aus- und Wiedereinbau der Sache bzw. zum Entfernen und Wiederanbringen derselben, unter den weiteren gesetzlichen Voraussetzungen von S + P ersetzt zu verlangen, wenn die vom Käufer hierzu bestimmte angemessene Frist fruchtlos verstrichen ist.

- Musste die durch S + P gelieferte Sache im Falle der Weiterveräußerung durch den Käufer zum Zwecke der Nacherfüllung bei dessen direktem oder einem weiteren Abnehmer in der Lieferkette aus- und wiedereingebaut bzw. entfernt und wiederangebracht werden, ist S + P dem Käufer gegenüber nicht zum Ersatz der hierfür angefallenen Aufwendungen verpflichtet.

- Stellt sich heraus, dass das Mangelbeseitigungsverlangen des Käufers unberechtigt war, kann S + P von ihm die entstandenen Kosten (insbesondere Prüf-, Ein- und Ausbau- sowie Transportkosten) ersetzt verlangen, es sei denn, die fehlende Mangelhaftigkeit war für den Käufer nicht erkennbar.

Die vorstehend unter lit. b) und c) genannten Besonderheiten gelten nicht im Falle von Aufwendungsersatz bei Endlieferung neu hergestellter Ware an einen Verbraucher (Lieferantenregress gem. §§ 478, 445a, 445b bzw. §§ 445c, 327 Abs. 5, 327u BGB), sofern nicht, z.B. im Rahmen einer Qualitätssicherungsvereinbarung, ein gleichwertiger Ausgleich vereinbart wurde.

6. In den Fällen der Lieferung von neu hergestellter Ware durch S + P, die am Ende der Lieferkette in unverarbeitetem Zustand durch einen Unternehmer an einen Verbraucher verkauft werden, auch wenn letzterer sie weiterverarbeitet hat, gelten für die Rechte des Käufers weiter folgende Besonderheiten:

- Die Ansprüche des Käufers aus § 478 BGB sind ausgeschlossen, soweit es sich um einen Mangel aufgrund von Werbeaussagen oder sonstigen vertraglichen Vereinbarungen handelt, die nicht von S + P herrühren, oder wenn der Käufer, sein unmittelbarer oder ein weiterer Abnehmer in der Lieferkette gegenüber dem Endverbraucher eine besondere Garantie abgegeben hat.

- Diese Ansprüche sind ebenfalls ausgeschlossen, wenn der Käufer, sein unmittelbarer oder ein weiterer Abnehmer in der Lieferkette selbst nicht aufgrund der gesetzlichen Regelungen zur Ausübung der Gewährleistungsrechte gegenüber dem Endverbraucher verpflichtet war oder diese Rüge gegenüber einem ihm gestellten Anspruch nicht vorgenommen hat. Dies gilt auch, wenn der Käufer, sein unmittelbarer oder ein weiterer Abnehmer in der Lieferkette gegenüber dem Endverbraucher Gewährleistungen übernommen hat, die über

das gesetzliche Maß hinausgehen.

- Die Ansprüche des Käufers aus § 478 BGB sind insgesamt ausgeschlossen, wenn der Käufer seinen gesetzlich geschuldeten Untersuchungs- und Rügepflichten nach näherer Maßgabe des Abschnitts VI Ziff. 1 nicht ordnungsgemäß nachgekommen ist.

#### VII. Sonstige Haftung

Schadensersatzansprüche wegen Verletzung einer außervertraglichen Pflicht (Haftung aus Delikt) oder wegen Verschuldens bei oder im Vorfeld des Vertragsschlusses (culpa in contrahendo) sowie aus sonstigen Rechtsgründen, insbesondere der Verletzung allgemeiner Rücksichtnahmepflichten (§ 241 Abs. 2 BGB), der fehlerhaften oder unterlassenen Ausführung von vor oder nach Vertragsschluss erfolgten Vorschlägen oder Beratungen oder der Verletzung sonstiger Vertragspflichten (§ 280 Abs. 1 BGB), soweit es sich nicht bereits um Gewährleistungsansprüche handelt, sind ausgeschlossen, soweit sie nicht auf ein vorsätzliches, arglistiges oder grob fahrlässiges Handeln unsererseits oder unserer Erfüllungsgehilfen oder auf der schuldhaften Verletzung wesentlicher Vertragspflichten beruhen.

Der Haftungsausschluss gilt nicht für Schäden, welche aus der Verletzung des Lebens, des Körpers oder der Gesundheit herrühren oder Garantien sowie Ansprüche aus dem Produkthaftungsgesetz betreffen.

Im Falle einer einfach fahrlässigen Verletzung einer wesentlichen Vertragspflicht haften wir allerdings nur für den nach Art des Vertragsschlusses vorhersehbaren, typischerweise eintretenden Schaden.

#### VIII. Verjährung

1. Abweichend von § 438 Abs. 1 Nr. 3 BGB beträgt die allgemeine Verjährungsfrist für Ansprüche aus Sach- und Rechtsmängeln einschließlich des Anspruchs auf Aufwendungsersatz in der Lieferkette nach § 445a Abs. 1, Abs. 3 BGB ein Jahr ab Ablieferung. Soweit eine Abnahme vereinbart ist, beginnt die Verjährung mit der Abnahme.

2. Handelt es sich bei der Ware jedoch um ein Bauwerk oder eine Sache, die entsprechend ihrer üblichen Verwendungsweise für ein Bauwerk verwendet worden ist und dessen Mangelhaftigkeit verursacht hat, beträgt die Verjährungsfrist gemäß der gesetzlichen Regelung fünf Jahre ab Ablieferung (§ 438 Abs. 1 Nr. 2 BGB). Unberührt bleiben auch weitere gesetzliche Sonderregelungen zur Verjährung (insbes. § 438 Abs. 1 Nr. 1, Abs. 3, §§ 444, 445b BGB).

3. Handelt es sich bei der Ware um solche Gegenstände, die für ein Bauwerk, aber auch für andere Dienst- und Werkleistungen verwendet werden können, verbleibt es bei der Verjährungsfrist gem. Ziff. 1, es sei denn, wenn der Einbau der Ware für das Bauwerk von wesentlicher Bedeutung war; dann gilt die Verjährungsfrist gem. Ziff. 2.

4. Abweichend von § 445b Abs. 2 S. 2 BGB endet im Falle der Weiterveräußerung der von S + P gelieferten Ware durch den Käufer gegenüber S + P die Ablaufhemmung hinsichtlich der Verjährung von Mängelansprüchen des Käufers drei Jahre nach Ablieferung der Ware.

5. Die vorstehenden Verjährungsfristen des Kaufrechts gelten auch für vertragliche und außervertragliche Schadensersatzansprüche des Käufers, die auf einem Mangel der Ware beruhen, es sei denn die Anwendung der regelmäßigen gesetzlichen Verjährung (§§ 195, 199 BGB) würde im Einzelfall zu einer kürzeren Verjährung führen. Schadensersatzansprüche des Käufers aus Vorsatz, grober Fahrlässigkeit, der Verletzung von Leben, Körper oder Gesundheit sowie aus Garantien oder dem Produkthaftungsgesetz verjähren jedoch ausschließlich nach den gesetzlichen Verjährungsfristen. Die Verkürzung der Verjährungsfrist bzw. der Ablaufhemmung gilt auch dann nicht, wenn es sich um einen Fall der Lieferung von Waren durch S + P handelt, die am Ende der Lieferkette in unverarbeitetem Zustand durch einen Unternehmer an einen Verbraucher verkauft werden (Rückgriff des Unternehmers - §§ 478, 479 BGB).

#### IX. Eigentumsvorbehalt

1. Die von uns gelieferte Ware bleibt bis zur Erfüllung sämtlicher bestehender oder künftig entstehender Forderungen, die uns aus irgendeinem Rechtsgrund aus der laufenden Geschäftsbeziehung und/oder dem konkreten Kaufvertrag gegenüber dem Käufer zustehen, unser Eigentum. Im Falle des vertragswidrigen Verhaltens des Käufers, z.B. Zahlungsverzug, haben wir nach vorheriger Setzung einer angemessenen Frist das Recht, die Vorbehaltsware zurückzunehmen. Nehmen wir die Vorbehaltsware zurück, stellt dies einen Rücktritt vom Vertrag dar. Pfänden wir die Vorbehaltsware, ist dies ein Rücktritt vom Vertrag. Wir sind berechtigt, die Vorbehaltsware nach der Rücknahme zu verwerten. Nach Abzug eines angemessenen Betrages für die Verwertungskosten, ist der Verwertungserlös mit den uns vom Käufer geschuldeten Beträgen zu verrechnen.

2. Der Käufer hat die Vorbehaltsware pfleglich zu behandeln und diese auf seine Kosten gegen Feuer-, Wasser- und Diebstahlschäden ausreichend zum Neuwert zu versichern. Wartungs- und Inspektionsarbeiten, die erforderlich werden, sind vom Käufer auf eigene Kosten rechtzeitig durchzuführen. Der Käufer ist außerdem verpflichtet, auf Verlangen von S + P, uns jederzeit über den Zustand der Ware Auskunft zu geben und den Aufbewahrungsort der Ware mitzuteilen.

3. Der Käufer ist berechtigt, die Vorbehaltsware im ordnungsgemäßen Geschäftsgang zu veräußern und/oder zu verwenden, solange er nicht in

Zahlungsverzug ist. Verpfändungen oder Sicherungsübereignungen sind unzulässig. Die aus dem Weiterverkauf oder einem sonstigen Rechtsgrund (Versicherung, unerlaubte Handlung) bezüglich der Vorbehaltsware entstehenden Forderungen (einschließlich sämtlicher Saldoforderungen aus Kontokorrent) tritt der Käufer bereits jetzt sicherungshalber in vollem Umfang an uns ab; wir nehmen die Abtretung hiermit an. Wir ermächtigen den Käufer widerruflich, die an uns abgetretenen Forderungen für dessen Rechnung im eigenen Namen einzuziehen. Die Einzugsermächtigung kann jederzeit widerrufen werden, wenn der Käufer seinen Zahlungsverpflichtungen nicht ordnungsgemäß nachkommt. Zur Abtretung dieser Forderung ist der Käufer auch nicht zum Zwecke des Forderungseinzugs im Wege des Factoring befugt, es sei denn, es wird gleichzeitig die Verpflichtung des Factors begründet, die Gegenleistung in Höhe der Forderungen solange unmittelbar an uns zu bewirken, als noch Forderungen von uns gegen den Käufer bestehen. Der Käufer ist außerdem verpflichtet, uns von einer Pfändung oder einer anderen Beeinträchtigung durch Dritte unverzüglich zu benachrichtigen.

4. Eine Verarbeitung oder Umbildung der Vorbehaltsware durch den Käufer wird in jedem Fall für uns vorgenommen. Sofern die Vorbehaltsware mit anderen, uns nicht gehörenden Sachen verarbeitet wird, erwerben wir das Miteigentum an der neuen Sache im Verhältnis des Wertes der Vorbehaltsware (Rechnungsendbetrag inklusive der Mehrwertsteuer) zu den anderen verarbeiteten Sachen im Zeitpunkt der Verarbeitung. Im Falle der untrennbaren Vermischung der Vorbehaltsware mit anderen, uns nicht gehörenden Sachen erwerben wir Miteigentum an der neuen Sache im Verhältnis des Wertes der Vorbehaltsware (Rechnungsendbetrag inklusive der Mehrwertsteuer) zu den anderen vermischten Sachen im Zeitpunkt der Vermischung. Ist die Sache des Käufers in Folge der Vermischung als Hauptsache anzusehen, sind der Käufer und wir uns einig, dass der Käufer uns anteilmäßig Miteigentum an dieser Sache überträgt; die Übertragung nehmen wir hiermit an. Unser so entstandenes Allein- oder Miteigentum an einer Sache verwarht der Käufer für uns. Für die durch Verarbeitung oder Umbildung entstehende neue Sache gilt das Gleiche wie für die Vorbehaltsware, allerdings mit der Einschränkung, dass der Käufer Forderungen Dritter lediglich in der Höhe an uns abtritt, als wir Miteigentum entsprechend dem zuvor Gesagten erworben haben.

5. Bei Zugriffen Dritter auf die Vorbehaltsware, insbesondere Pfändungen, wird der Käufer auf unser Eigentum hinweisen und uns unverzüglich benachrichtigen, damit wir unsere Eigentumsrechte durchsetzen können. Soweit der Dritte nicht in der Lage ist, uns die in diesem Zusammenhang entstehenden gerichtlichen oder außergerichtlichen Kosten zu erstatten, haftet hierfür der Käufer.

6. Wir sind verpflichtet, die uns zustehenden Sicherheiten insoweit freizugeben, als der realisierbare Wert unserer Sicherheiten die zu sichernden Forderungen um mehr als 10 % übersteigt, dabei obliegt uns die Auswahl der freizugebenden Sicherheiten.

#### X. Gerichtsstand, anzuwendendes Recht

1. Ist der Käufer Kaufmann i.S.d. Handelsgesetzbuchs, juristische Person des öffentlichen Rechts oder ein öffentlich-rechtliches Sondervermögen, ist ausschließlicher – auch internationaler – Gerichtsstand für alle sich aus dem Vertragsverhältnis unmittelbar oder mittelbar ergebenden Streitigkeiten Heilbronn, Deutschland. Entsprechendes gilt, wenn der Käufer Unternehmer i.S.v. § 14 BGB ist. Wir sind jedoch in allen Fällen auch berechtigt, Klage am Erfüllungsort der Lieferverpflichtung gem. diesen AVB bzw. einer vorrangigen Individualabrede oder am allgemeinen Gerichtsstand des Käufers zu erheben. Vorrangige gesetzliche Vorschriften, insbesondere zu ausschließlichen Zuständigkeiten, bleiben unberührt. 2. Das Rechtsverhältnis zwischen uns und unseren Kunden oder zwischen uns und Dritten regelt sich ausschließlich nach dem in der Bundesrepublik Deutschland geltenden Recht unter Ausschluss internationalen Einheitsrechts, insbesondere des UN-Kaufrechts.

#### XI. Sonstiges

1. Sollten diese Bestimmungen teilweise rechtsunwirksam oder lückenhaft sein oder werden oder durch eine Sondervereinbarung ausgeschlossen sein, so wird hierdurch die Gültigkeit der übrigen Bestimmungen nicht berührt.

2. Wir weisen darauf hin, dass wir Daten unserer Kunden im Rahmen unserer gegenseitigen Geschäftsbeziehungen nach den geltenden datenschutzrechtlichen Bestimmungen, insbesondere der Europäischen Datenschutz-Grundverordnung und dem Bundesdatenschutzgesetz speichern.

Schäfer + Peters GmbH

# General Terms of Sale and Delivery of Schäfer + Peters GmbH (hereinafter referred to as "S + P") Version 10/2022

## I. Scope of Validity

1. The terms of sale given hereinafter apply to all contracts concluded between the Purchaser and S + P concerning the delivery of goods, provided that the Purchaser is a company, legal entity under public law or special fund under public law. Contracts are executed exclusively on the basis of the following conditions. The quotation, the quotation acceptance and the order confirmation, as well as the sale of any product, are subject to these conditions. We shall not recognise any contradictory or deviating conditions of purchase, unless we have expressly agreed to apply these conditions. This consent requirement shall always apply, particularly if we carry out the Purchaser's order without qualification and in full knowledge of these contradictory or deviating conditions of the Purchaser.
2. In the contracts, all agreements that have been made between the Purchaser and S + P about the execution of the purchasing contracts up to the time of the respective conclusion of the contract are documented in writing. The effectiveness of individual agreements made retroactively in individual cases remains unaffected.
3. If S + P and the Purchaser have arranged a framework agreement, these General Terms of Sale shall apply both to this framework agreement and to the individual delivery or purchase order.
4. The General Terms of Sale shall also apply to all future business relationships, even if these terms are never agreed on expressly.

## II. Offer and Contract Conclusion

1. We can accept an order from the Purchaser which is to be qualified as a legally binding offer for the conclusion of a purchasing contract within two weeks by sending an order confirmation or by rendering the deliveries or services ordered without qualification, with the choice being ours.
2. Our quotations are non-binding, unless we have expressly designated them as binding. Information about our goods (particularly technical data, dimensions, performance and consumption data, as well as the descriptions in the respective product information or advertising materials, etc.) is only approximate and roughly representative, provided that usability for the contractually intended purpose does not require an exact match; this information does not guarantee the condition, unless this guarantee is made expressly and in writing.
3. We retain our property right, copyright and other protective rights on all figures, calculations, drawings and other documents. The Purchaser may only pass on these items, regardless of whether we have marked them as confidential, to third parties in text form as such or in terms of content, disclose them, use them themselves or have them used by third parties or reproduce them with our consent.
4. Information about current warehouse inventory is always non-binding. If inventory is communicated to the customer, this is considered inventory that is specifically reserved for customer or volume groups and does not need to be identical to the actual inventory.

## III. Terms of Payment

1. Our prices apply to the scope of service and delivery indicated in the order confirmations. Additional or special services are billed separately. Prices shall apply ex works in Öhringen, plus packaging, duties, insurance and, in individual cases, additional taxes and duties, if not otherwise specified. The statutory value added tax is not included in our prices. We list this in the invoice separately in the statutory amount on the date the invoice is issued.
2. Unless otherwise agreed, invoices shall be due and payable without deduction within 30 days from the date of invoicing and delivery. We grant a discount of 2% for payments made within 10 days of the date of invoice, unless the Purchaser is in default of payment for other payment obligations towards us. Payment is only considered to have occurred once the funds are available to us. In the case of cheque payments, payment is only considered to have occurred once the cheque has cleared.
3. If the Purchaser does not pay within the defined period, the Purchaser shall be in default of payment, without a new payment request needing to be made. In the case of late payment, interest is to be paid on the purchase price at the legally applicable late payment interest rate for business owners. Further claims shall remain unaffected. If the Purchaser does not render payment upon further request, we are entitled to make all existing obligations of the Purchaser due and payable, in particular also deferred or instalment payments, and to deny any further deliveries.
4. The Purchaser shall be authorised to offset and/or withhold payment only if the counter-claims have been determined as legally valid, have been recognised by us, are indisputable or if the counter-claims arise from the same specific contractual relationship as the principal claim and are in a mutual relationship with this claim.
5. If S + P has granted instalment payments for the Purchaser, the remaining amount shall be due and payable in full if the Purchaser is in default of payment of an instalment by more than 8 days.
6. Price changes are permitted if more than four months have passed between the contract conclusion and the agreed delivery date and if the price change can be traced back to a recent cost increase for which we are not liable. A cost increase has occurred if wages, material costs, transport costs ancillary transport costs or sales costs increase before delivery. The same applies if duties

increase or a duty is introduced, or cost changes result due to price increases of upstream suppliers or due to exchange rate fluctuations. In these cases, S + P is authorised to increase the price appropriately in accordance with the cost increases.

## IV. Delivery and Service Period, Liability in Case of Late Delivery

1. Delivery dates or deadlines that are not agreed upon or promised by us expressly as binding are exclusively non-binding specifications. They shall only be considered approximations and describe a likely delivery date. Agreements or promises about a binding delivery date deviating from this must be made expressly and in writing. The delivery period only begins when the Purchaser has properly and completely performed those cooperation activities that are obligatory on its part.
2. If we do not receive deliveries or services from our sub-suppliers or sub-contractors, or do not receive correct or timely deliveries or services for reasons for which we are not responsible despite proper coverage, or if an event of force majeure occurs, we shall inform our customer in writing in a timely manner. In this case, we are authorised to extend the delivery or service period by the duration of the temporary hindrance or, in the case of a significant hindrance whose duration is not temporary, to withdraw from the part of the contract that has not yet been fulfilled, entirely or in part, if we have performed the above obligation of notification and have not assumed the procurement risk or production risk. Force majeure includes any other unforeseeable event upon contract conclusion, such as legal strikes or lockouts, government interventions, energy and resource shortages, transport bottlenecks or operational disturbances through no fault of our own, such as those due to fire, water and machine damage, unexpectedly occurring pandemics or epidemics, acts of war and war-like acts, economic sanctions and all other hindrances for which we objectively cannot be held responsible. If the delivery or service is delayed by more than one month as a result of one of the cases named above in Clauses 1 and 3, both we and the customer regardless of the deadline requirement for the customer and excluding any claims for damages are authorised to withdraw from the contract with regard to the volume affected by the delivery disturbances. The customer is authorised to withdraw from the entire contract if a partial delivery is unacceptable for the customer.
3. In any case, we shall enter into default of delivery only after an appropriate grace period set by the customer has passed, unless time is of the essence for the transaction as defined by § 286 para. 2 No. 4 of the German Civil Code (BGB) or § 376 of the German Commercial Code (HGB).
4. Our legal rights, particularly in the case of an exclusion of the duty to perform (e.g. due to impossibility or unreasonableness of performance and/or supplementary performance), remain unaffected. Claims for damages due to delayed delivery are excluded, provided that they are not based on any intentional or grossly negligent actions on our part or on the part of our subcontractors, or based on the culpable violation of essential contractual duties. Essential contractual duties are any that protect the essential legal positions of the customer, the guarantee of which is the very essence and purpose of the contract; these also include those contractual duties whose performance enables the proper completion of the contract in the first place and those whose observance the contract partner frequently trusts and may reasonably trust. The exclusion of liability does not apply to damages caused by injury to life, limb and health or damages affecting warranties. In the case of a simple negligent violation of an essential contractual duty, however, we shall only accept liability for typical, immediate, average damage foreseeable at the time that the contract was concluded.
5. We are only authorised to perform partial deliveries and partial services if:
  - the partial delivery or partial service is usable for the customer as part of the intended purpose of the contract.
  - the delivery of the remaining ordered goods or the rendering of the remaining commissioned services is ensured, and
  - this does not cause any significant added outlay or extra costs for the customer (unless we have agreed to accept these costs).
6. If the Purchaser is in default of acceptance, we are then entitled to demand compensation for accrued damages and any extra expenses. The same applies if the Purchaser culpably violates its cooperation duties.

## V. Place of Fulfilment, Transfer of Risk, Shipping, Packaging

1. Delivery shall be ex warehouse in Öhringen, which is also the place of performance for the delivery. This shall also apply in the event of subsequent performance. At the request and expense of the Purchaser, the goods will be shipped to another destination (sale by delivery to a place other than the place of performance).
2. The risk of accidental loss and accidental deterioration of the goods shall transfer to the Purchaser upon handover at the latest. In the case of sales shipment, however, the risk of accidental destruction and accidental deterioration of the goods, as well as the risk of delay, passes to the shipper, freight carrier or other person or institution assigned to complete the shipment upon handover of the goods for shipment. Handover is still considered to have taken place if the Purchaser is in default of acceptance.
3. With regard to the shipment method and shipping route, we shall try to take into consideration the wishes and interests of the Purchaser; added costs cau-

sed by this – even in the case of agreed free delivery – shall be borne by the Purchaser.

4. We do not take back transport packaging or any other packaging in accordance with the packaging ordinance; this excludes pallets. The Purchaser shall take care of disposal of the packaging, which becomes its property, at the Purchaser's own expense.

5. If the shipping is delayed on the request of or due to fault of the Purchaser, we shall store the goods at the Purchaser's risk and expense. In this case, the notice of readiness to ship shall be deemed equivalent to shipment.

6. On request and at the expense of the Purchaser, we shall insure the delivery using transport insurance. This requires an instruction from the Purchaser given expressly and in writing.

#### **VI. Warranty/Limitation of Liability/Compensation for Wasted Expenditures**

1. There shall only be claims for defects from the Purchaser if the Purchaser has properly fulfilled its legally required examination and notification duties, particularly in accordance with § 377 HGB. Regardless of the legal requirements for proper examination, the Purchaser shall at least examine the supplied goods after delivery at its location or that of a third party designated by the Purchaser carefully and in a reasonable scope – if applicable, through random checks – at least for dimensional accuracy, material, weight and surface condition. Defects that are revealed in this way shall be indicated to us in writing within one week of receipt of goods. If this does not occur, the goods shall be considered accepted. Hidden defects shall be communicated to S + P immediately after their discovery in writing. A proper notification of a defect shall indicate the willingness of the Purchaser to send back the rejected delivered goods on the request of S + P with freight prepaid. In the case of a justified notification of a defect, S + P shall compensate the Purchaser for the cost of the most economical shipping route; this shall not apply if costs increase because the delivered goods are located somewhere other than the place of intended use. If the Purchaser fails to carry out a proper inspection and/or to give notice of a defect, our liability for the defect which was not notified or not notified in time or not notified properly shall be excluded in accordance with the statutory provisions. In the case of goods intended for installation or mounting, this shall also apply if the defect only became apparent after the corresponding processing as a result of the breach of one of these obligations; in this case, the Purchaser shall, in particular, have no claims for reimbursement of the corresponding costs (dismantling and installation costs).

2. The legal regulations apply to the rights of Purchaser in the case of quality defects and defects of title (including incorrect and under delivery as well as improper assembly or defective assembly instructions), if not otherwise specified in preceding or following provisions.

3. The basis of our liability for defects is above all the agreement reached on the quality and the presupposed use of the goods (including any accessories and instructions). All product descriptions and manufacturer's specifications which are the subject of the individual contract or which were publicly announced by us (in particular in catalogues or on our Internet homepage) at the time of the conclusion of the contract shall be deemed to be an agreement on quality in this sense. Insofar as the quality was not agreed, it shall be assessed in accordance with the statutory regulation whether a defect exists or not (§ 434 para. 3 BGB (German Civil Code)). Public statements made by the manufacturer or on its behalf, in particular in advertising or on the label of the goods, take precedence over statements made by other third parties.

4. Independent of the preceding and following provisions, the legal regulations shall apply in the following cases:

- intentional actions on our part;
- damage due to injury to life, limb and health;
- claims in accordance with product liability law;
- if warranties taken over by us are excluded by deviating provisions.

In all cases, the special statutory provisions on the reimbursement of expenses in the case of final delivery of the newly manufactured goods to a consumer (supplier's recourse pursuant to §§ 478, 445a, 445b or §§ 445c, 327 para. 5, 327u BGB (German Civil Code)) shall remain unaffected, unless equivalent compensation has been agreed, e.g. within the scope of a quality assurance agreement.

5. Otherwise, the following aspects apply to the rights of the Purchaser in the case of quality defects and defects of title:

a) Liability for compensation for damages and compensation for wasted expenditures

Claims for damages due to defects of title and quality defects are excluded, provided that they are not

- based on grossly negligent actions on our part or on the part of our subcontractors, or

- based on the culpable violation of essential contractual duties. Essential contractual duties are any that protect the essential legal positions of the customer, the guarantee of which is the very essence and purpose of the contract; these also include those contractual duties, the performance of which enables the proper completion of the contract in the first place and on the observance of which the contracting partner frequently trusts and may reasonably trust.

In the event of a simple negligent breach of an essential contractual obligation,

we shall only be liable for the typically foreseeable damage according to the type of contract conclusion.

Claims for compensation for wasted expenditures in accordance with § 284 BGB (German Civil Code) shall be waived if and insofar as, as stated previously, a claim for compensation for damages in place of performance has been effectively disclaimed.

b) Supplementary performance

- If the delivered item is defective, we can initially choose whether we shall provide subsequent performance by remedying the defect (rectification) or by delivering an item free of defects (replacement delivery). If the type of subsequent performance chosen by us is unreasonable for the Purchaser in the individual case, he may reject it. Our right to refuse subsequent performance under the statutory preconditions remains unaffected.

- If the Purchaser has already installed the goods delivered by S + P into another object or attached them to another object at its location, the Purchaser must offer us the opportunity to remove the goods ourselves and reinstall or reattach improved or additional goods ourselves, provided that this is reasonable for the Purchaser, for the purposes of supplementary performance, and to define an appropriate period for this. This shall apply regardless of whether we were originally required to install or assemble goods in addition to their delivery; using this approach, the installation or assembly of delivered goods does not become part of supplementary performance.

- If the Purchaser has already resold the goods delivered by S + P, the Purchaser shall set a prior and appropriate period for S + P for supplementary performance if the Purchaser has to take back the goods from its customer as a result of the defect or if the Purchaser's customer has reduced the purchase price.

- Our right to refuse supplementary performance in accordance with the legal requirements remains unaffected.

c) Compensation for expenses for supplementary performance

- The Purchaser is only entitled to demand compensation from S + P for expenses incurred by it for the purpose of subsequent performance, in particular for the removal and reinstallation of the item or for the removal and reinstallation of the same, under the further statutory conditions, if the reasonable period of time set by the Purchaser for this purpose has elapsed without success.

- If, in the case of resale by the Purchaser, the object delivered by S + P needed to be removed and reinstalled or removed and reattached at the location of a direct customer of the Purchaser or a different customer in the supply chain for the purposes of supplementary performance, S + P is not required to compensate the Purchaser for the expenses that arise from this.

- If it is revealed that the request for rectification from the Purchaser is unjustified, S + P can demand compensation from the Purchaser for the costs arising (particularly testing, installation, removal and transport costs), unless the lack of defect was not able to be determined by the Purchaser.

The special aspects mentioned above under items b) and c) do not apply in the case of reimbursement of expenses in the case of final delivery of newly manufactured goods to a consumer (supplier recourse according to §§ 478, 445a, 445b or §§ 445c, 327 para. 5, 327u BGB (German Civil Code)), unless equivalent compensation has been agreed, e.g. within the framework of a quality assurance agreement.

6. In case of delivery of newly produced goods by S + P that are sold at the end of the supply chain in unprocessed form by a business owner to a consumer, even if the latter has further processed it, the following additional aspects apply to the rights of the Purchaser:

- Claims of the Purchaser based on § 478 BGB are excluded, provided that they involve a defect based on advertising statements or other contractual agreements not originating from S + P, or if the Purchaser, its immediate customer or another customer in the supply chain has provided a special guarantee to the end user.

- Claims are also excluded if the Purchaser itself, its immediate customer or another customer in the supply chain was not required to exercise warranty rights toward the end user in accordance with legal regulations or if the Purchaser has not objected to a claim asserted against it. This also applies if the Purchaser, its immediate customer or another customer in the supply chain has taken over warranties vis-a-vis the end user that exceed the legal requirements.

- The claims of the Purchaser based on § 478 BGB (German Civil Code) are excluded as a whole if the Purchaser has not properly fulfilled its legally required examination and notification duties in accordance with the detailed specifications of Section VI No. 1.

#### **VII. Other Liability**

Claims for damages due to a violation of a non-contractual duty (liability based on tort) or due to fault during or before the conclusion of the contract (culpa in contrahendo) as well as any other legal basis, particularly the violation of general duties arising from an obligation (§ 241 para. 2 BGB (German Civil Code)) or other contractual duties (§ 280 para. 1 BGB), provided that this does not involve warranty claims, are excluded, provided that they are not based on intentional, fraudulent or grossly negligent actions on our part or on the part of our subcontractors or based on culpable violation of essential contractual duties.

The exclusion of liability does not apply to damages caused by injury to life, limb and health or damages affecting warranties and claims in accordance with

product liability law.

In the case of a simple negligent violation of an essential contractual duty, however, we shall only accept liability for typical, immediate, average damage foreseeable at the time that the contract was concluded.

#### **VIII. Limitation**

1. Deviating from § 438 para. 1 No. 3 BGB (German Civil Code), the general limitation period for claims due to quality defects and defects of title, including the claim for reimbursement for expenses in the supply chain in accordance with § 445a para. 1, para. 3 BGB, is one year from delivery. If an acceptance has been agreed, the limitation begins upon acceptance.

2. However, if the goods constitute a building or an object that has been used as a building in the typical manner and has resulted in its defectiveness (building material), the limitation period pursuant to Clause 1 shall apply, unless the installation of the goods was of essential importance for the building. In that case, the limitation period pursuant to Clause 2 shall apply.

3. If the goods are items that can be used for a building, but also for other services and works, the limitation period pursuant to Clause 1 shall apply, unless the installation of the goods was of essential importance for the building. In that case, the limitation period pursuant to Clause 2 shall apply.

4. Deviating from § 445b Par. 2 S. 2 BGB, in the case of resale of the goods delivered by S + P by the Purchaser, the suspension of expiration regarding the limitation of defect claims from the Purchaser toward S + P ends three years after delivery of the goods.

5. The present limitation periods from the sale of goods law shall also apply to contractual and non-contractual claims for damages from the Purchaser based on a defect of the goods, unless the application of the regular legal limitation (§§ 195, 199 BGB) would lead to a shorter limitation in this individual case. However, claims for damages from the Purchaser due to wilful intent, gross negligence, injury to life, limb and health as well as warranties or product liability law expire by limitation only after the legal limitation periods. The shortening of the limitation period or the suspension of expiration shall also not apply if the matter involves the delivery of goods by S + P that are sold at the end of the supply chain in an unprocessed state by a business owner to a consumer (Recourse of the entrepreneur – §§ 478, 479 BGB).

#### **IX. Retention of Title**

1. The goods delivered by us shall remain our property up to the fulfilment of all existing claims or claims arising in future owed to us on any legal basis from the ongoing business relationship and/or specific purchasing contract with the Purchaser. In the case of the Purchaser behaviour that is contrary to the contract (e.g. payment default), we have the right to take back the reserved goods after first setting an appropriate period. If we take back the reserved goods, this represents a withdrawal from the contract. If we seize the reserved goods, this is a withdrawal from the contract. We are authorised to utilize the reserved goods after taking them back. After withdrawing an appropriate amount for the utilisation costs, the proceeds of utilisation shall offset the amounts owed to us by the Purchaser.

2. The Purchaser shall treat the reserved goods with care and insure them against damage due to fire, water and theft sufficiently at original value at its own expense. The maintenance and inspection work that is required shall be performed by the Purchaser at its own expense in a timely manner. Furthermore, upon request by S + P, the Purchaser shall at any time notify us of the state of the goods and communicate the storage place of the goods.

3. The Purchaser is authorised to dispose of or use the reserved goods in the normal course of business, provided that the Purchaser is not in default of payment. Pledges or assignments as security are not permitted. The Purchaser shall assign claims arising from resale or another legal basis (insurance, tort) regarding the reserved goods (including all current account balance claims) to us in full scope as security; this statement constitutes our acceptance of the assignment. We revocably authorise Purchaser to collect claims assigned to us for Purchaser's account and in its own name. This collection authorisation can be revoked at any time if Purchaser does not properly fulfil its payment obligations. Purchaser shall also not be authorised to assign this claim for the purposes of debt collection by way of factoring, unless the obligation of the factor is simultaneously established to effect the consideration in the amount of the debts directly to us for as long as we still have claims against the Purchaser. The Purchaser shall furthermore obligated notify us immediately of any seizure or other interference by a third party.

4. Any transformation of the reserved goods by the Purchaser is always carried out on our behalf. If the reserved goods are processed with other items which do not belong to us, we shall acquire co-ownership of the new item in proportion to the value of the reserved goods (total invoice amount including value-added tax) to the other processed items at the time of the processing. In the case of inseparable combination of the reserved goods with other items that do not belong to us, we shall acquire co-ownership of the new item in proportion to the value of the reserved goods (total invoice amount including value-added tax) to the other combined items at the time of the combination. If the Purchaser's item is to be considered the main item as a result of combination, we and the Purchaser agree that the Purchaser shall transfer co-ownership of this item

to us on a proportional basis; this statement constitutes our acceptance of this transfer. Our sole or co-ownership of an item arising from this shall be kept for us by the Purchaser. The same applies to the new item created through processing or transformation as to the reserved goods, but with the limitation that the Purchaser shall only assign claims of third parties to us in the amount that we have acquired through co-ownership according to the previous statement.

5. In case of access of third parties to the reserved goods, particularly seizures, the Purchaser shall indicate our property to the third parties and immediately notify us so that we may assert our property rights. If the third party is not able to reimburse us for the legal or out-of-court costs arising in this context, the Purchaser shall be liable for this.

6. We shall release the securities due to us insofar as the realisable value of our securities exceeds the secured claims by more than 10%, in which process we are at liberty to select the securities to be released.

#### **X. Place of Fulfilment, Jurisdiction, Applicable Law**

1. If the Purchaser is a merchant within the meaning of the German Commercial Code, a legal entity under public law or a special fund under public law, the exclusive – including international – place of jurisdiction for all disputes arising directly or indirectly from the contractual relationship shall be Heilbronn, Germany. The same shall apply if the buyer is an entrepreneur within the meaning of § 14 BGB (German Civil Code). However, we are also entitled in all cases to bring an action at the place of performance of the delivery obligation in accordance with these general terms of sale and delivery or a prior individual agreement or at the general place of jurisdiction of the buyer. Priority statutory provisions, in particular regarding exclusive jurisdiction, shall remain unaffected.

2. The legal relationship between us and our customers or between us and third parties shall be governed exclusively by applicable law in the Federal Republic of Germany, excluding international uniform law, particularly the UN Convention on Contracts for the International Sale of Goods.

#### **XI. Other**

1. If these provisions are or become partially void or incomplete or are excluded by a special agreement, the validity of the remaining provisions shall not be affected by this.

2. We would like to note that we store data of our customers as part of our mutual business relationships in accordance with applicable data protection regulations, particularly the European General Data Protection Regulation and the German Data Protection Act.

Schäfer + Peters GmbH

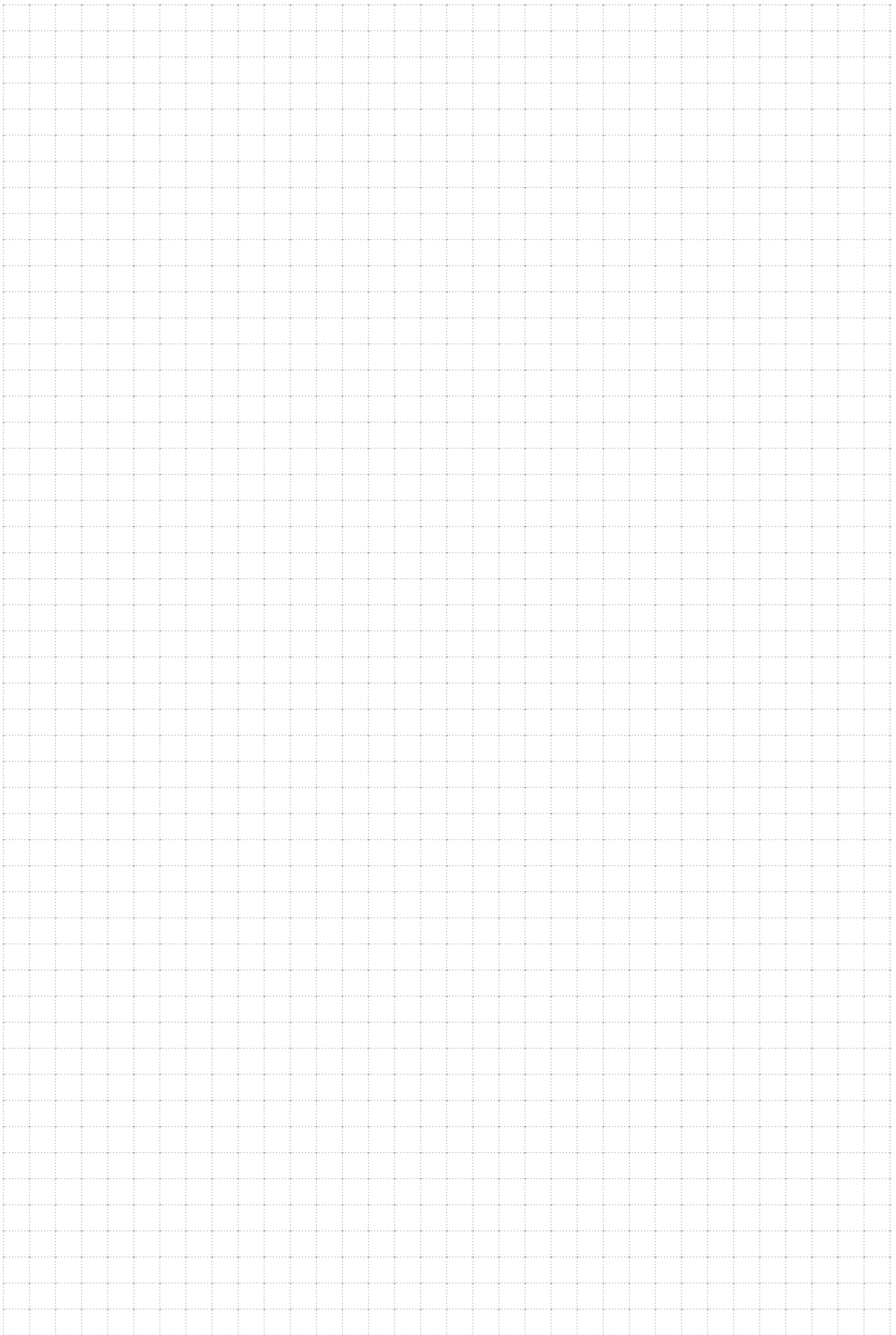





**Schäfer + Peters GmbH**

Zeilbaumweg 32  
DE-74613 Öhringen

Tel. +49 (0) 7941 6094-0  
Fax +49 (0) 7941 6094-700

[info@schaefer-peters.com](mailto:info@schaefer-peters.com)  
[www.schaefer-peters.com](http://www.schaefer-peters.com)

